

**RANGER 8980E**  
**DOWNLOADABLE CONTROL COMMUNICATOR**  
**INSTALLATION MANUAL**

**TABLE OF CONTENTS**

GENERAL DESCRIPTION .....	2
STANDARD AND OPTIONAL PARTS LIST .....	2
FEATURE DEFINITIONS .....	3
TERMINAL DRAWING AND SPECIAL NOTES .....	4
TERMINAL & FUSE DESCRIPTION .....	5
HOW TO PROGRAM THE RANGER 8980E .....	6
KEYPAD PROGRAMMING EXAMPLES .....	7
PROGRAMMING PHONE NUMBERS & FORMATS .....	8 - 9
COMMUNICATOR FORMAT SELECTION GUIDE .....	9
OPTIONAL PROGRAMMING INSTRUCTIONS .....	10 - 27
DOWNLOAD PROGRAMMING INSTRUCTIONS .....	28
ADDITIONAL COMMENTS ABOUT THE 8980E .....	28
PROGRAMMING WORKSHEETS .....	29 - 32
APPENDIX 1 - REPORTING SIA FORMAT .....	33
APPENDIX 2 - REPORTING CONTACT ID .....	34
UNDERWRITERS LABORATORIES REQUIREMENTS .....	35
LOCAL TELEPHONE COMPANY INTERFACE INFO .....	36
SPECIFICATIONS & WARRANTY .....	38

**CADDX CONTROLS, INC.**

**GLADEWATER, TEXAS**

**800-727-2339**

# RANGER 8980E INSTALLATION MANUAL

## General Description

The Caddx Ranger 8980E is a versatile 8 zone up/downloadable security control with a built-in digital communicator. Its microcomputer design gives some of the most versatile, yet easy-to-use features available for most security applications today. Each of the eight zones can be programmed to be one of ten different types including 24-Hour, Interior Follower, and Day zone. Each zone is individually annunciated and can be bypassed from the keypad. See page ? for a description of all zone types. Read the User's Manual before you begin the installation for the best overall description of how the Ranger 8980E functions. After installation of the security system, complete the information on page 1 of the User's Manual and explain the system operation to all security system owners/operators.

## Standard Parts List

The Ranger 8980E is shipped with the parts listed below.

QUANTITY	PARTS DESCRIPTION	PART #
1	MASTER CONTROL PANEL	8985E
1	REMOTE KEYPAD	8981
1	16.5VAC 25VA TRANSFORMER	T-1625
10	3.3K ½ WATT E.O.L. RESISTORS	EOL-33
1	INSTALLATION MANUAL	IM-8980E
1	USER'S MANUAL	OM-8980E

## Optional Parts List

The following parts are available for use with the Ranger 8980E.

OPTIONAL PARTS DESCRIPTION	PART #
REMOTE KEYPAD *	8982
LCD ALPHA NUMERIC KEYPAD *	9050
DOWNLOADING SOFTWARE *	DL-900
PROGRAMMER WITH DIGITAL NUMERIC DISPLAY	8950
12VDC 6AH BATTERY	B-1260
END OF LINE DEVICE FOR U.L. 985 FIRE ZONE	EOL-34UL

\* These parts have not been tested by Underwriters Laboratories.

## FEATURE DEFINITIONS

**INTERNAL EVENT LOG** - Up to 80 events can be stored in memory along with the date and time of the event. These events can later be viewed through downloading.

**TELEPHONE LINE MONITOR** - The Ranger 8980E has a telephone line monitor that monitors the voltage and current of the telephone line for a detection of a faulted phone line. See locations 194 & 195, page 23.

**KEYSWITCH ARMING** - Keyswitch arming/disarming can be accomplished by using the remote arming input on the PC board, and the auxiliary outputs. It is not necessary to waste a hardwire zone to accommodate Keyswitch arming/disarming.

**SECONDARY EXIT DELAY** - Used most often for garage doors, this zone type is a second entry/exit delay that has its own delay times, independent of the standard entry/exit delay zone.

**BUILT IN SIREN DRIVER** - The Ranger 8980E has a built-in 112db siren driver. When desired, this built-in driver can be easily converted to a 1 amp voltage output through programming. See location 132, page 15.

**QUICK ARM FEATURE** - The Ranger 8980E has a one button "Quick Arm" code which can be used to arm the system by pressing one digit at the keypad. The "Quick Arm" digit is programmed in location 139 on page 16.

**GROUP BYPASS** - A designated group of zones can be programmed to bypass by pressing the [\*][9][\*] keys before arming. In order to bypass a group of designated zones, you must press This feature is enabled in Locations 244-251: *Assigning Special Characteristics For Zones*, on page 27.

**ENTRY-GUARD** - This unique low level arming mode has been developed to reduce the most common source of false alarms. When armed in this mode, the opening of any zones designated as "Entry Guard zones" will initiate the keypad sounder and start a delay (see locations 244-251) before creating an alarm. This arming mode will encourage system owners to use their system more frequently when the premises is occupied.

**CHIME** - If so programmed, this feature can be turned on and off by entering the first digit of the Master code. When the system is in the disarmed state, the opening of selected zones will create a one second tone through the keypad sounder. This lowest level of security can be enabled by zone on page 23, in locations 186-193:

**FORCE ARMING** - When enabled in location 197, the Ranger 8980E can be armed with zones violated, lacking a green "Ready" light on the keypad. Under this condition, all zones that are not secure at the end of the exit delay will become bypassed. All zones that become secured before the end of the exit delay will become active in the system.

**AUTOMATIC ARMING** - The Ranger 8980E can be programmed to Automatically Arm at a predesignated time of day, if it has not already been armed. See location 202, page 24.

**DUAL/SPLIT REPORTING** - The Ranger 8980E can be programmed for dual and/or split reporting.

**AUTOMATIC BYPASS/INSTANT ARMING** - When enabled, the control panel can automatically bypass interior follower zones if an exit is not detected during the delay time, and delayed zones can be made instant. See location 131, on page 16 of this manual for the different combinations of programming this feature.

**DYNAMIC BATTERY TEST** - When enabled in location 203, the Ranger 8980E can be programmed to perform a dynamic battery test for a selected duration, at 6:00 AM.

**FIRE ALARM VERIFICATION** - When enabled in location 143, the Ranger 8980E has the ability to verify a Fire alarm by requiring more than one trip on a smoke detector before creating an alarm.

**ALARM HISTORY** - Five seconds after pressing the [0] key, the keypad will annunciate "Freeze Frame" alarm history. The zone LED's will indicate which zone(s) caused the last alarm, regardless of the number of times the Ranger 8980E has been armed or disarmed since that alarm. It annunciates by blinking the zone LED(s) that caused the alarm, and lighting steady those that were bypassed when that alarm occurred. The annunciation will continue for 5 seconds. Alarm History is erased when the Ranger 8980E is put into the program mode. A burglary zone that has been bypassed due to "Swinger Shutdown" will alternate between continuous and blinking.

**WARNING** CONTINUED PROTECTION AGAINST THE

RISK OF FIRE REPLACE ONLY WITH THE SAME TYPE AND RATING OF FUSE

F1 = FACTORY REPLACEABLE ONLY

F2 = 1 AMP F3 = 2 AMP F4 = 1 AMP

**WARNING** PREVENT RISK OF ELECTRIC SHOCK

ALWAYS DISCONNECT THE TELEPHONE LINE PRIOR TO SERVICING

VOLTAGE SIREN



NOTE: PHONE LINE MONITOR SHUNT MUST BE REMOVED WHEN DOWNLOADING WITH OUT A PHONE LINE

- TRANSMISSION OF THE FIRE ALARM SIGNAL TO A FIRE ALARM HEADQUARTERS OR CENTRAL STATION SHALL BE PERMITTED ONLY WITH THE APPROVAL OF THE LOCAL AUTHORITY HAVING JURISDICTION

- THE BURGLAR ALARM SIGNAL SHALL NOT BE TRANSMITTED TO A POLICE EMERGENCY NUMBER

- EQUIPMENT IS TO BE INSTALLED IN ACCORDANCE WITH NFPA (985.55.1.P)

FOR UL LISTED SYSTEMS USE ESL 465C OR EQUIVALENT SMOKE DETECTOR

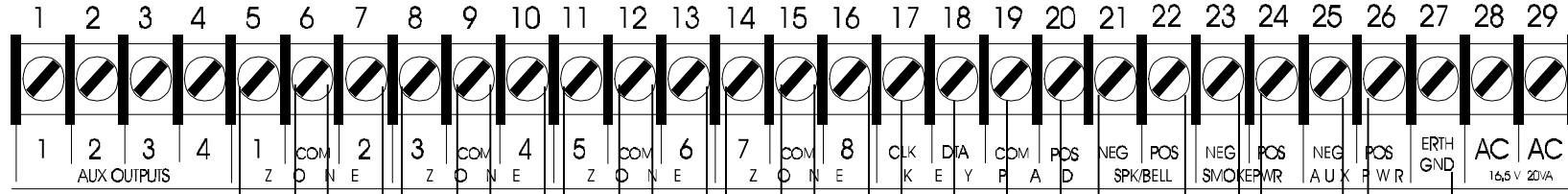
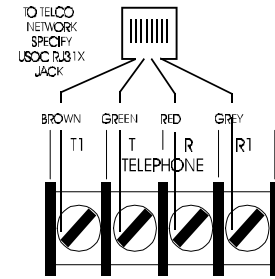

AUXILIARY OUTPUTS CURRENT LIMITED TO 250 MICROAMPS WHEN OUTPUT IS POSITIVE AND 25 mA WHEN OUTPUT IS NEGATIVE.

1. ALL ZONES MUST HAVE END OF LINE (E.O.L.) RESISTOR ATTACHED AS SHOWN
2. MAXIMUM LOOP RESISTANCE 300 OHMS
3. FOR UL LISTED SYSTEMS USE ONLY ALARM INITIATING SERVICES RATED AT 10.8 TO 13.8 VOLTS DC.

FIRE LOOP HOOK UP WHEN PERMITTED BY LOCAL JURISDICTION

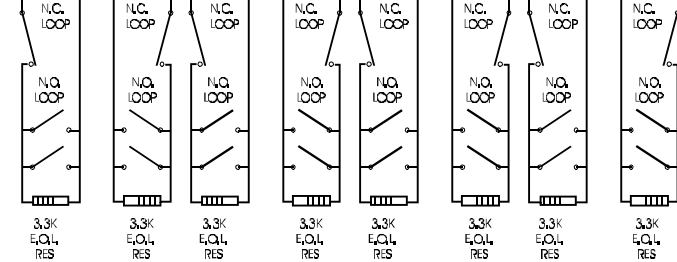

UL LISTED E.O.L. SUPERVISION RELAY (PYROTECTOR 20-40-12) OR EQUIVALENT

FOR ADDITIONAL INFORMATION AND INSTRUCTIONS REFER TO THE INSTALLATION MANUAL CADDX BULLETIN IV-8980E AND THE OPERATORS MANUAL CADDX BULLETIN OM-8980

- 1) MAXIMUM 4 KEYPADS
- 2) MAXIMUM WIRE RUN PER KEYPAD  
a. 22 GAUGE WIRE: 200 FEET  
b. 18 GAUGE WIRE: 500 FEET
- 3) DO NOT DAISSY CHAIN KEYPADS. EACH MUST HAVE AN INDIVIDUAL WIRE RUN.
- 4) ADDITIONAL KEYPADS DRAW 60 mA

- FOR UL LISTED SYSTEMS
1. CURRENT FROM TERM 22 MUST NOT EXCEED 1 AMP LESS CURRENT DRAWN FROM TERMINALS 20, 24 AND 26
  2. USE ONLY DEVICES RATED AT 10.8 TO 13.8 VOLTS DC.

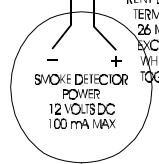

BUILT IN SIREN DRIVER FOR 15 OR 30 WATT SPEAKERS 4 OR 16 OHM LOAD. B BELL IS USED PROGRAM LOC 132 AND PLACE JUMPER ON VOI 5D1. FUSED AT 2 AMPS BY F3. FOR U-985 AND 1023 USE WHEELLOCK BELL 461G-12R AND PROGRAM FOR A VOLTAGE OUTPUT.

AUXILIARY POWER 12 VOLTS DC 600 mA MAX INCLUDING SMOKE DETECTOR POWER FUSED AT 1 AMP BY F2

TOTAL STANDBY CURRENT DRAWN FROM TERM 20, 24 AND 26 MUST NOT EXCEED 500mA WHEN ADDED TOGETHER.

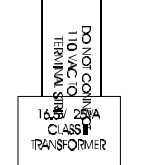

DO NOT CONNECT TO A RECEPTACLE THAT IS CONTROLLED BY A SWITCH

COLD WATER PIPE GROUND

**LIGHTNING PROTECTION**  
THE CONTROL PANEL MUST BE EARTH GROUNDED FOR LIGHTNING PROTECTION TO WORK EFFECTIVELY, THE GROUND CONNECTION SHOULD BE TO A VERIFIED COLD WATER GROUND PIPE OR A DEDICATED DRIVEN METAL ROD 8 TO 10 LONG. USE MINIMUM 14 GAUGE WIRE.

BATTERY CAPACITY FOR EMERGENCY STANDBY AT LEAST 4 HOURS CONTROL PANEL DRAWS 80 mA IN STANDBY

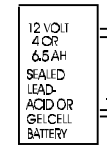

TERMINAL DRAWING & SPECIAL NOTES

ZONE 1	_____	ZONE 5	_____
ZONE 2	_____	ZONE 6	_____
ZONE 3	_____	ZONE 7	_____
ZONE 4	_____	ZONE 8	_____

**CADDX  
RANGER  
8980E**  
CADDX CONTROLS, INC.,  
GLADEWATER, TX 75647

## TERMINAL DESCRIPTION

TERMINAL	DESCRIPTION
1-4	Programmable Auxiliary Output Terminals
5	Connect one side of zone 1 loop. The other side of loop to common terminal 6. Open or short causes alarm.
6	Common (-) Terminal
7	Connect one side of zone 2 loop. The other side of loop to common terminal 6. Open or short causes alarm.
8-16	See Terminal Drawing and repeat the above sequence for zones 3-8 .
17,18,19,20	Connect keypad wires as follows; yellow to terminal 17, green to terminal 18, black to terminal 19, red to terminal 20. 200 ft. maximum run with 22 gauge wire, 500 ft. maximum run with 18 gauge wire. Home run cable to each keypad.
21(-)& 22(+)	Siren driver output to speaker(s), (speaker rating should be 15 watt at 8 or 16 ohm, or 30/40 watt at 4, 8, or 16 ohms). If siren driver disable is selected in location 132, output becomes voltage output, 12VDC, 1 Amp maximum load.
23(-)& 24(+)	Smoke detector power 12VDC, 100 mA maximum (For those jurisdictions which allow the Priority zone to be used with smoke detectors.)
25(-)& 26(+)	Auxiliary power, regulated 12VDC, 500 mA maximum.
27	Earth Ground, connect to a cold water pipe or 6 to 10 foot driven rod.
28 & 29	AC input, connect a 16.5V 25 VA, Class II U.L. approved transformer (included).
T1	(T1) House Telephone Tip (brown)
T	(T) Telephone Tip (green)
R	(R) Telephone Ring (red)
R1	(R1) House Telephone Ring (gray)
Battery Leads	Battery leads Standby battery leads black(-) and red(+) connect to a 12VDC lead acid rechargeable battery. Do not connect to a dry cell battery.

## FUSE DESCRIPTION

FUSE #	DESCRIPTION
F2	KEYPAD (1 AMP)
F3	SPEAKER / BELL (2 AMP)
F4	AUXILIARY / SMOKE DETECTOR POWER (1 AMP)

## PROGRAMMING

The Ranger 8980E can be placed into the "Program" mode by use of the **9075 Smart Programmer**, the 8950 programmer, or for Keypad programming, by utilizing the 9050 LCD Keypad or the 8601 LED Keypad. These methods are described below:

### Using a Programmer

Plug the optional 8950 Programmer into the 4-pin male outlet marked "PROGRAMMER" on the Ranger 8980E PC Board and the control will enter the program mode. The 8950 will program locations "000" through "255" of the 8980E control (See using the LED Keypad below.) When using a 9075 Smart Programmer, please refer to the 9075 Manual.

### Using The LCD Keypad

The most straightforward method of Keypad programming is to utilize the 9050 LCD Keypad in the programming mode. To access the programming mode enter [C]-[0]-[0], followed by the four digit "Go To Program" access code which is factory default [9]-[0]-[5]-[0] (this code can be reprogrammed), and follow the Keypad prompts. (See using the LED Keypad below.)

### Using The LED Keypad

The 8980E can also be programmed by the standard binary method of Keypad programming described below. When the 8601 LED Keypad is used for programming, enter the factory default four digit "Go To Program" access code of [9]-[7]-[1]-[3]. NOTE: The 8980E must be disarmed to gain access to programming with this code. After entry of this code, the 8980E will be in the "Program" mode, and the yellow LED's will display the data in location 000. The data is displayed using a Binary system. With this system the yellow zone 1 LED equals "1" when illuminated. The zone 2 LED equals "2" when illuminated. The zone 3 LED equals "4" when illuminated. The zone 4 LED equals "8" when illuminated. Thus if the data in location 000 is "9", the LED for zone 1 (=1) and zone 4 (=8) would be illuminated. By adding the two values together, (1+8=9) you would determine that the data in location 000 is "9". If the data in location 000 is "6", the LEDs for zone 2 (=2) and zone 3 (=4) would be added (2+4=6) indicating the data in that location to be "6". If no LED's are illuminated, the location contains a "0". To advance from location 000 through 255, press the [#] key. To go to a specific location, press the location number followed by the [#] key. The yellow LED's will then display the data in that location. Data is changed by entering a number 0 to 15 followed by [\*] (\* = data enter). Review the examples in figure 1 on the following page.

### Important Function Codes

**[9]-[1]-[0]-[#]** When in the program mode, this function code can be used to write original factory default codes into the 8980E.

**[9]-[2]-[0]-[#]** When in the program mode (after data has been entered into locations 000-255), you must enter [9]-[2]-[0]-[#] to permanently load the information into the EEPROM. **IF THIS STEP IS NOT TAKEN, THE DATA IN THE EEPROM WILL NOT CHANGE, AND THE RANGER 8980E WILL NOT CHANGE CHARACTERISTICS.**

**[9]-[3]-[0]-[#]** This function code is used to exit the programming mode after it was accessed via the Keypad.

**[2]-[3]-[0]-[#]** This function code is used to exit the programming mode after it was accessed via the 9050 LCD Keypad.

## PROGRAMMING EXAMPLE - FIGURE 2

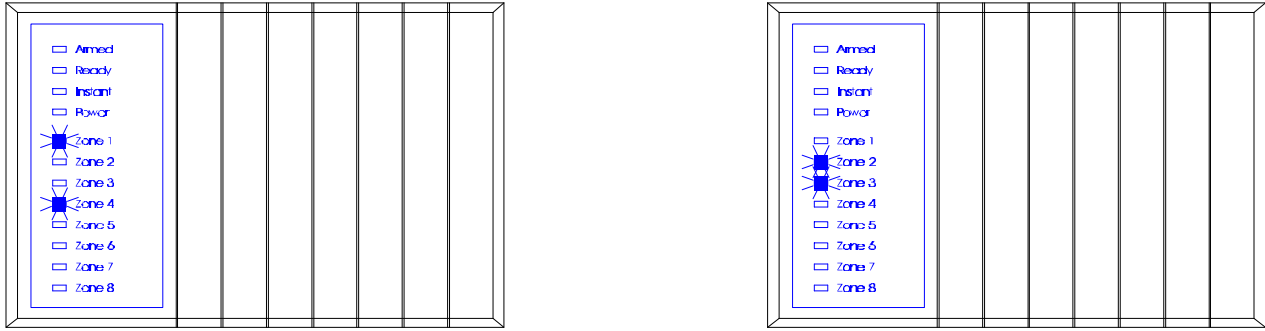

ZONE 1 LED = 1  
 ZONE 4 LED = 8 } DATA = 9

ZONE 2 LED = 2  
 ZONE 3 LED = 4 } DATA = 6

No LED's Illuminated = 0

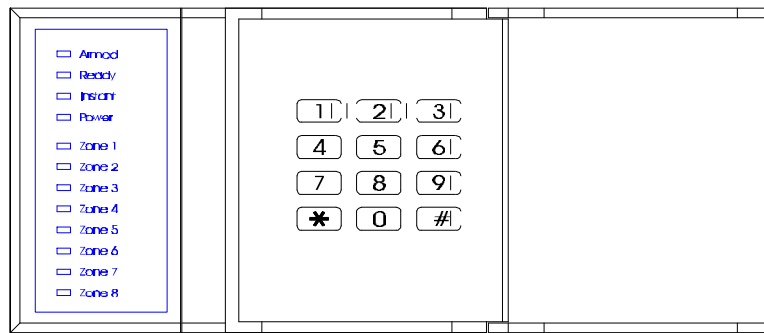

To change or enter data in location shown, enter data and follow by the [\*] Key.

Pressing the [#] Key will advance to next location, or specific location can be reached by pressing location number followed by the [#] Key.

## 8950 PROGRAMMER - FIGURE 3

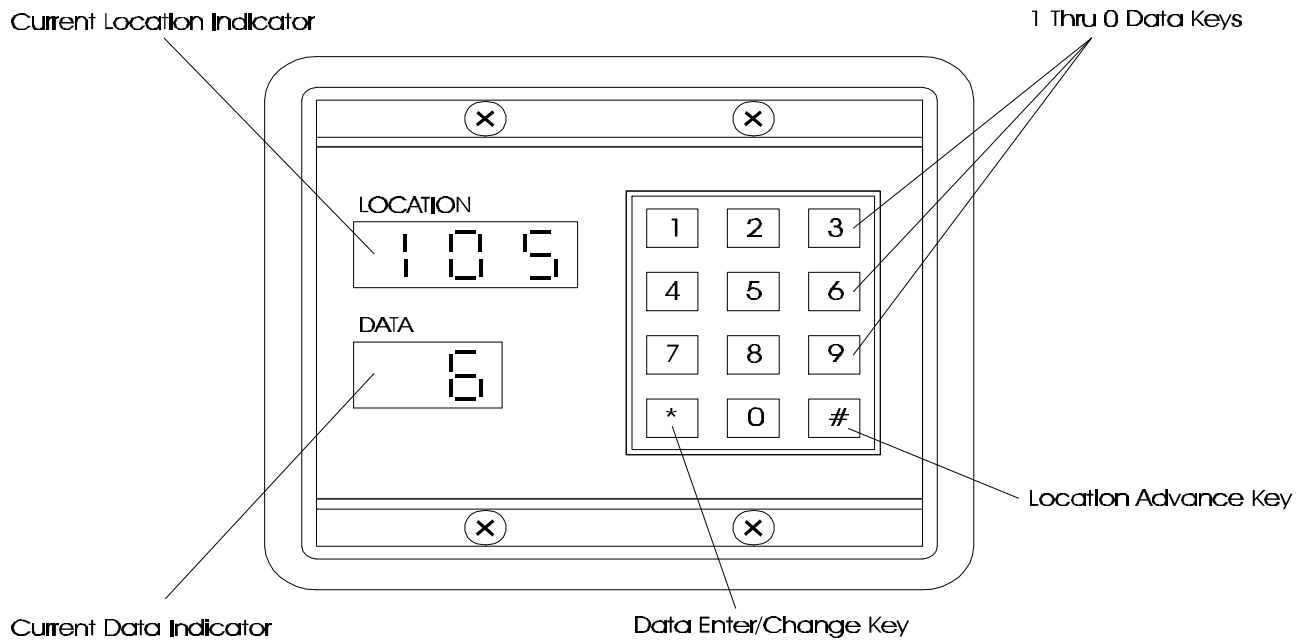

**PAGES 8 & 9 DESCRIBE ALL THE LOCATIONS WHICH MUST BE PROGRAMMED FOR THE RANGER 8980E TO FUNCTION AND REPORT TO A CENTRAL STATION. OTHER OPTIONS MAY BE SELECTED BY FOLLOWING THE ADDITIONAL PROGRAMMING INSTRUCTIONS.**

**LOCATIONS 032-047: PROGRAMMING THE PRIMARY TELEPHONE NUMBER**

The primary telephone number is programmed in successive locations beginning with location 032. Any zero (0) within the telephone number, must be programmed as a "10". A "0" indicates the end of the phone number. Delays of four seconds can be programmed at any point in the phone number by programming a "13" in the appropriate location. If tone dialing is desired, program a "15" in the location where tone dialing should begin. If the entire number should be tone dialing, program a "15" in location 032. To dial a \*, program an "11". To dial a #, program a "12". When using split reporting, the primary number always takes priority over the secondary telephone number.

**LOCATIONS 048-051: PROGRAMMING THE ACCOUNT CODE FOR THE PRIMARY PHONE NUMBER**

The account code sent when the PRIMARY phone number is dialed is programmed in locations 048-051. Any zero (0) within the account code must be programmed as a "10", and the communicator will report a zero (0). If the account code is three digits long, use locations 048,049, and 050, and program a "0" in location 051 to indicate the end of the account code.

**LOCATION 052: PROGRAMMING COMMUNICATOR FORMAT FOR THE PRIMARY PHONE NUMBER**

Location 052 contains the communicator format used to transmit to the receiver connected to the primary phone number. Consult the instructions for your central station receiver to determine which format is compatible. To select **Ademco/Silent Knight Fast**, program a "2" in location 052. **Radionics 1800HZ/2300HZ Fast w/Parity and Hex Capability** requires a "9" in this location. For a **Pager** format, program a "15" in this location, along with the appropriate data in locations 208 and 209. If you need another format, choose from those listed in the format table located on the following page, and program the data in location 052. If this location contains a "0", the built-in communicator will be disabled, and the Ranger 8980E will function as a local only control.

**LOCATION 053: DISABLING THE SECONDARY TELEPHONE NUMBER AS A BACKUP**

Location 053 is used to disable the secondary phone number as a "backup". This feature can be used with split reporting (locations 176-177) to prevent a report from going to the secondary telephone number after unsuccessful attempts to the primary phone number. Programming a "0" will make the secondary phone number backup the primary, and the primary phone number backup the secondary. Programming a "3" will make the control alternate from the primary to the secondary number (2 calls each) for the number of attempts programmed in location 134. If location 053 contains a "1", only the primary phone number will be called.

**LOCATIONS 054-069: PROGRAMMING THE SECONDARY TELEPHONE NUMBER**

Locations 054-069 contain the secondary telephone number. This number allows certain communicator reports to go to another number, or to cause the communicator to dial a second number if the primary number does not respond after the number of attempts programmed in location 134 have been tried unsuccessfully. The same number of attempts are made with the back-up number. Tone dialing and delay instructions are the same as for the primary number.

**LOCATIONS 070-073: PROGRAMMING THE ACCOUNT CODE FOR THE SECONDARY PHONE NUMBER**

Locations 070-073 contain the account code for the secondary phone number. Any zero (0) within the account code must be programmed as a "10", and the communicator will report a zero (0). If the account code is three digits long, use locations 070, 071, and 072, and program a "0" in location 073 to indicate the end of the account code. If these locations are left blank, the account code in locations 048-051 will be reported.



**LOCATION 074: PROGRAMMING COMMUNICATOR FORMAT FOR THE SECONDARY TELEPHONE NUMBER**

Location 074 contains the communicator format for the secondary phone number. Consult the instructions for your central station receiver to determine which format is compatible. To select **Ademco/Silent Knight Fast**, program a "2" in this location. **Radionics 1800HZ/2300HZ Fast with Parity and Hex Capability** requires a "9" in this location. For a **Pager** format, program a "15" in this location, along with the appropriate data in locations 208 and 209. If you need another format, choose from those listed in the format table below, and program the appropriate data in this location. If location 074 is "0", the format programmed in location 052 will be used.

DATA	FORMAT	DESCRIPTION
"0"	LOCAL ONLY	THE COMMUNICATOR IS DISABLED
"1"	UNIVERSAL 4 + 2	1800HZ TRANSMIT 2300HZ HANDSHAKE DOUBLE ROUND PARITY 40 PPS.
"2"	ADEMCO/SILENT KNIGHT FAST	1900HZ TRANSMIT 1400HZ HANDSHAKE DOUBLE ROUND PARITY 20 PPS.
"3"	CADDX MODEM	PROPRIETARY
"4"	SESCOA SUPERFAST	1800HZ TRANSMIT 2300HZ 4/2
"5"	EXTENDED RADIONICS SLOW	1800HZ TRANSMIT 2300HZ HANDSHAKE DOUBLE ROUND PARITY 20 PPS EXTENDED HEX CAPABILITY
"6"	EXTENDED RADIONICS SLOW	1800HZ TRANSMIT 1400HZ HANDSHAKE DOUBLE ROUND PARITY 20 PPS EXTENDED HEX CAPABILITY
"7"	EXTENDED RADIONICS FAST	1800HZ TRANSMIT 2300HZ HANDSHAKE DOUBLE ROUND PARITY 40 PPS EXTENDED HEX CAPABILITY
"8"	EXTENDED RADIONICS FAST	1800HZ TRANSMIT 1400HZ HANDSHAKE DOUBLE ROUND PARITY 40 PPS EXTENDED HEX CAPABILITY
"9"	EXTENDED RADIONICS FAST WITH PARITY	1800HZ TRANSMIT 2300HZ HANDSHAKE SINGLE ROUND W/PARITY 40 PPS EXTENDED HEX CAPABILITY
A="10"	EXTENDED RADIONICS FAST WITH PARITY	1800HZ TRANSMIT 1400HZ HANDSHAKE SINGLE ROUND W/PARITY 40 PPS EXTENDED HEX CAPABILITY
B="11"	ADEMCO 4 + 2 EXPRESS	DTMF
C="12"	SILENT KNIGHT 4 + 2	1900HZ TRANSMIT 1400 HANDSHAKE DOUBLE ROUND 20PPS
D="13"	ADEMCO CONTACT ID	DTMF (SEE APPENDIX 2)
E="14"	SIA	FSK (SEE APPENDIX 1)
F="15"	PAGER/CUSTOM FORMAT	SEE OVER-RIDE LOCATIONS 182, 183, 208, 209.

**LOCATIONS 000-003: PROGRAMMING THE MASTER ARM/DISARM CODE**

Locations 000-003 contain master arm/disarm code (user number 1). Location 000 contains the first digit of the code; location 003 contains the fourth digit of the code. THE CODE MUST CONTAIN FOUR (4) DIGITS. The master code can then be used in the run mode to enter arm/disarm codes 1-7. The factory default code is [1]-[2]-[3]-[4]. NOTE: User codes 8 thru 14 can only be accessed from the installers programming level in locations 212-239.

## **LOCATIONS 004-023: PROGRAMMING THE ARM/DISARM CODE FOR USERS 2 THRU 6**

Locations 004-023 contain the arm/disarm codes for user numbers 2 thru 6. Location 004 contains the first digit of the code #2, and location 007 contains the fourth digit of code #2. THESE CODES MUST CONTAIN FOUR (4) DIGITS. To disable a code, PROGRAM a "15" as the first digit of the code. These codes can be changed in the RUN mode using the master code. User codes 8 thru 14 (locations 212-239) can be accessed from the program mode only.

## **LOCATIONS 024-027: PROGRAMMING THE DURESS CODE OR USER 7**

Locations 024-027 contain the arm/disarm code for Duress or for user number 7. Duress capability is enabled by programming a communicator code in locations 086-087. If locations 086-087 are left unprogrammed, user number 7 will act as a standard user code. If the maintenance code option is selected in location 167, locations 024-027 should not be programmed.

## **LOCATIONS 028-031: PROGRAMMING THE "GO TO PROGRAM" ACCESS CODE**

Locations 028-031 contain the "Go To Program" access code. Location 028 contains the first digit of the code and location 031 contains the fourth digit of the code. THE CODE MUST CONTAIN FOUR (4) DIGITS. With the Ranger 8980E disarmed, the "Go To Program" access code can be used to enter the program mode. To disable the "Go To Program" access code, program a "15" in location 028. The factory default setting is [9][7][1][3].

## **LOCATIONS 032-074: SEE PAGES 8 & 9**

## **LOCATION 075: PROGRAMMING THE ENTRY DELAY TIME**

Location 075 contains the number of 10 second increments in the entry delay. The entry delay can be programmed in 10 second increments from 10 to 150 seconds ("1" = 10 seconds through "15" = 150 seconds). For example, programming a "2" in this location will produce an entry delay of 20 seconds. (Note: A "0" entry is treated as 0 seconds). Programming a "6" in this location will produce an entry delay of 60 seconds. Factory default is 30 seconds.

## **LOCATION 076: PROGRAMMING THE EXIT DELAY TIME**

Location 076 contains the number of 10 second increments in the exit delay. The exit delay can be programmed in 10 second increments from 10 to 150 seconds ("1" = 10 seconds through "15" = 150 seconds). For example, programming a "2" in this location will produce an exit delay of 20 seconds. (Note: A "0" entry is treated as 0 seconds). Programming a "6" in this location will produce an exit delay of 60 seconds. Factory default is 60 seconds.

## **LOCATION 077: PROGRAMMING THE SIREN SHUTDOWN/RECYCLE TIMEOUT**

Location 077 contains the number of 2 minute increments in the automatic cutoff time. The automatic cutoff time can be programmed in 2 minute increments from 2 to 30 minutes ("1" = 2 min thru "15" = 30 min). For example, programming a "2" in this location will produce an automatic cutoff time of 4 minutes. Programming a "6" in this location will produce an automatic cutoff time of 12 minutes.

## **LOCATIONS 078-085: PROGRAMMING THE ZONE TYPES**

Locations 078 through 085 contain a number identifying the characteristics of each of the 8 zones. Location 078 corresponds to zone 1 and location 085 corresponds to zone 8. Each zone will factory default according to the programming worksheet. To program zone characteristics other than the default values, program a number from "1" to "10" based on the zone types available in the chart on the following page.

DATA	AVAILABLE ZONE TYPES
"1"	<b>DAY ZONE</b> - When armed, a trip produces an instant alarm. When disarmed, a trip activates the keypad sounder.
"2"	<b>24 HOUR</b> - A trip on a 24 Hour zone produces an instant alarm when armed or disarmed.
"3"	<b>ENTRY/EXIT</b> - A trip will start entry delay. The lack of a trip during exit delay will enable the Automatic Bypass or Instant mode if so programmed.
"4"	<b>INTERIOR DELAY</b> - A trip on Interior Delay zone will initiate an entry delay. It will be ignored during exit delay and when disarmed .
"5"	<b>INTERIOR FOLLOWER</b> - Interior zone that follows the delay zones. It is instant during non-delay times. It can be bypassed before arming, or by allowing it to automatically be bypassed in the Automatic Bypass/Instant mode if so programmed.
"6"	<b>INSTANT</b> - Produces an instant alarm if tripped when armed. Ignored when disarmed.
"7"	<b>24 HOUR SILENT</b> - A trip on a 24 hour silent zone will communicate to the central station when the Ranger 8980E is armed or disarmed.
"8"	<b>FIRE (PRIORITY WHEN AHJ HAS NOT APPROVED)</b> - A short on a FIRE zone (non-bypassable) will communicate to the central station when the Ranger 8980E is armed or disarmed. An open will create a Trouble condition. Keypad LED will be steady for FIRE, and flashing for Trouble.
"9"	<b>SECONDARY DELAY</b> - A secondary delay zone works like an entry/exit delay zone but has its own independent delay time (see locations 178-179).
"10"	<b>SUPERVISED 24 HOUR SILENT</b> - A trip on a Supervised 24 hour silent zone will communicate to the central station when the 8980E is armed/ disarmed, and give LED indication of the zone(s) faulted.

**NOTE: WHEN PROGRAMMING THE FOLLOWING COMMUNICATOR CODES, A "10" MUST BE PROGRAMMED IN ORDER TO REPORT A ZERO (0).**

#### **LOCATION 086-087: PROGRAMMING THE RANGER 8980E FOR DURESS CODE CAPABILITY**

The Ranger 8980E has the ability to report a duress code when the system is armed or disarmed with user code number 7 and a duress communicator code is programmed in locations 086-087. If both locations are "0", the duress capability is disabled and user code number 7 can only be used as a standard arm/disarm code. Location 086 contains the standard digit, and location 087 contains the extended digit. When using 4+2 format, the number programmed in location 086 is sent as the "ones" digit. The "tens" digit is programmed in location 087. **NOTE: ENABLING THE MAINTENANCE CODE FEATURE IN LOCATION 167 WILL AUTOMATICALLY DISABLE THE DURESS FEATURE.**

#### **LOCATION 088-089: PROGRAMMING FOR AUXILIARY 1, [1] & [3] DOUBLE KEYPRESS**

The Ranger 8980E has the ability to report an Auxiliary 1 code and activate the Priority siren each time the [1] and [3] keys are pressed simultaneously on the keypad. The desired reporting code is programmed in locations 088-089. If both locations are "0", the Auxiliary 1 double keypress is disabled. Location 088 contains the standard digit, and location 089 contains the extended digit. When using a 4+2 format, the number programmed in location 088 is sent as the "ones" digit. The "tens" digit is programmed in location 089. If activated, the siren can be silenced by entering any arm/disarm code.

#### **LOCATION 090-091: PROGRAMMING FOR AUXILIARY 2, [4] & [6] DOUBLE KEYPRESS**

The Ranger 8980E has the ability to report an Auxiliary 2 code and activate the pulsing buzzer each time the [4] and [6] keys are pressed simultaneously on the keypad. The desired Auxiliary 2 code is programmed in locations 090-091. If both locations are "0", the Auxiliary 2 double keypress is disabled. Location 090 contains the standard digit, and location 091 contains the extended digit. When using 4+2 format, the number programmed in location 090 is sent as the "ones" digit. The "tens" digit is programmed in location 091. If activated, the keypad sounder can be silenced by entering any Arm/Disarm code.

### **LOCATION 092-093: PROGRAMMING FOR KEYPAD PANIC, [\*] & [#] DOUBLE KEYPRESS**

The Ranger 8980E has the ability to report a Keypad panic code and activate the Burg siren each time the [\*] and [#] keys are pressed simultaneously on the keypad. The desired Keypad panic code is programmed in locations 092-093. If both locations are "0", the Keypad panic double keypress is disabled. Location 092 contains the standard digit, and location 093 contains the extended digit. When using 4+2 format, the number programmed in location 092 is sent as the "ones" digit. The "tens" digit is programmed in location 093. If activated, the siren can be silenced by entering any Arm/Disarm code.

### **LOCATION 094-095: PROGRAMMING THE TAMPER FEATURE**

The Ranger 8980E has an optional tamper feature that, when enabled, will lock out the keypads for 1 minute if 30 random keypresses are made without producing a valid code. The desired tamper code should be programmed in locations 094-095. If the control is not programmed for local only, the tamper will be communicated. If both locations are "0", the tamper feature will not be enabled or reported. Location 094 contains the standard digit, and location 095 contains the extended digit. When using 4+2 format, the number programmed in location 094 is sent as the "ones" digit. The "tens" digit is programmed in location 095.

### **LOCATION 096-097: PROGRAMMING TO REPORT DOWNLOADING COMPLETE**

Locations 096-097 contain the communicator report sent each time a download session has been completed. The report will come in after a disconnect has been made from a downloading session. Location 096 contains the standard communicator code, and location 097 contains the extended communicator code. When using a 4+2 format, the number programmed in location 096 is sent as the "ones" digit. The number programmed in location 097 is sent as the "tens" digit. When using an extended format, the extended report will be sent if location 097 contains a number other than "0". If locations 096-097 are "0", this report is disabled.

### **LOCATION 098-099: PROGRAMMING FOR AUTOTEST REPORTS**

The Ranger 8980E has the ability to send autotest reports at intervals from 1 to 15 days. Locations 098-099 contain the communicator codes sent for autotest. Location 098 contains the standard communicator code, and location 099 contains the extended communicator code. When using a 4+2 format, the number programmed in location 098 is sent as the "ones" digit. The number programmed in location 099 is sent as the "tens" digit. When using an extended format, the extended report will be sent if location 099 contains a number other than "0". If locations 098-099 are "0", autotest is disabled. (NOTE: WHEN USING AUTOTEST, LOCATIONS 152-166 MUST BE PROGRAMMED.)

### **LOCATION 100-101: PROGRAMMING TO REPORT FAILURE TO COMMUNICATE**

The 8980E has the ability to communicate each time communication is re-established after a signal has been unable to report. The data that failed to communicate will not be sent, but can be recovered from the log. The desired "Failure To Communicate" code is programmed in locations 100-101. If both locations are "0", "Failure To Communicate" will not be reported. Location 100 contains the standard digit, and location 101 contains the extended digit. When using 4 + 2 format, the number programmed in location 100 is sent as the "ones" digit. The "tens" digit is programmed in location 101.

### **LOCATION 102: PROGRAMMING TO REPORT CLOSINGS**

The Ranger 8980E has the ability to report a closing code each time the control is armed. The desired closing code is programmed in location 102. If this location contains a "0", closings will not be reported. When using 4+2 format, the number programmed in this location is sent as the "tens" digit. The "ones" digit is automatically the man number. When using the remote arming input, the man number is 1. When using a one button "Quick Arm" code the man number is 1. The closing report will not be initiated until the end of the exit delay. When using automatic arm, the man number is 9.

### **LOCATION 103: PROGRAMMING TO REPORT OPENINGS**

The Ranger 8980E has the ability to report an opening code each time the control is disarmed. The desired opening code is programmed in location 103. If this location contains a "0", openings will not be reported. When using 4+2 format, the number programmed in this location is sent as the "tens" digit. The "ones" digit is automatically the man number. When using the remote arming input, the man number is 1.

### **LOCATION 104-105: PROGRAMMING THE COMMUNICATOR CODE FOR ZONE 1**

Locations 104-105 contain the communicator code to be reported each time zone 1 creates an alarm. Location 104 contains the standard digit, and location 105 contains the extended digit. When using 4+2 format, the number programmed in location 104 is sent as the "ones" digit. The "tens" digit is programmed in location 105.

### **LOCATION 106-107: PROGRAMMING THE COMMUNICATOR CODE FOR ZONE 2**

Locations 106-107 contain the communicator code to be reported each time zone 2 creates an alarm. Location 106 contains the standard digit, and location 107 contains the extended digit. When using 4+2 format, the number programmed in location 106 is sent as the "ones" digit. The "tens" digit is programmed in location 107.

### **LOCATION 108-109: PROGRAMMING THE COMMUNICATOR CODE FOR ZONE 3**

Locations 108-109 contain the communicator code to be reported each time zone 3 creates an alarm. Location 108 contains the standard digit, and location 109 contains the extended digit. When using 4+2 format, the number programmed in location 108 is sent as the "ones" digit. The "tens" digit is programmed in location 109.

### **LOCATION 110-111: PROGRAMMING THE COMMUNICATOR CODE FOR ZONE 4**

Locations 110-111 contain the communicator code to be reported each time zone 4 creates an alarm. Location 110 contains the standard digit, and location 111 contains the extended digit. When using 4+2 format, the number programmed in location 110 is sent as the "ones" digit. The "tens" digit is programmed in location 111.

### **LOCATION 112-113: PROGRAMMING THE COMMUNICATOR CODE FOR ZONE 5**

Locations 112-113 contain the communicator code to be reported each time zone 5 creates an alarm. Location 112 contains the standard digit, and location 113 contains the extended digit. When using 4+2 format, the number programmed in location 112 is sent as the "ones" digit. The "tens" digit is programmed in location 113.

### **LOCATION 114-115: PROGRAMMING THE COMMUNICATOR CODE FOR ZONE 6**

Locations 114-115 contain the communicator code to be reported each time zone 6 creates an alarm. Location 114 contains the standard digit, and location 115 contains the extended digit. When using 4+2 format, the number programmed in location 114 is sent as the "ones" digit. The "tens" digit is programmed in location 115.

### **LOCATION 116-117: PROGRAMMING THE COMMUNICATOR CODE FOR ZONE 7**

Locations 116-117 contain the communicator code to be reported each time zone 7 creates an alarm. Location 116 contains the standard digit, and location 117 contains the extended digit. When using 4+2 format, the number programmed in location 116 is sent as the "ones" digit. The "tens" digit is programmed in location 117.

### **LOCATION 118-119: PROGRAMMING THE COMMUNICATOR CODE FOR ZONE 8**

Locations 118-119 contain the communicator code to be reported each time zone 8 creates an alarm. Location 118 contains the standard digit, and location 119 contains the extended digit. When using 4+2 format, the number programmed in location 118 is sent as the "ones" digit. The "tens" digit is programmed in location 119.

### **LOCATION 120-121: PROGRAMMING TO REPORT AC POWER LOSS**

The Ranger 8980E has the ability to report an AC power failure code when AC power is lost. This report can be immediate, or delayed depending on the information programmed in location 150 AC POWER LOSS DELAY. The desired AC failure mode should be programmed in locations 120-121. If both locations are "0", AC power failures will not be reported. Location 120 contains the standard digit, and location 121 contains the extended digit. When using 4+2 format, the number programmed in location 120 is sent as the "ones" digit. The "tens" digit is programmed in location 121.

### **LOCATION 122-123: PROGRAMMING TO REPORT LOW BATTERY**

The Ranger 8980E can perform a dynamic battery test and report a low battery code when the battery has discharged down to 10.3 volts. The desired low battery code is programmed in locations 122-123. If both locations are "0", low battery will not be reported. Location 122 contains the standard digit, and location 123 contains the extended digit. When using 4+2 format, the number programmed in location 122 is sent as the "ones" digit. The "tens" digit is programmed in location 123.

### **LOCATION 124: PROGRAMMING FOR PRIORITY ZONE TROUBLE REPORTING**

The Ranger 8980E has the ability to report a trouble code each time a Priority zone opens. The desired trouble code is programmed in location 124. If this location contains a "0", the Priority Trouble will not be reported.

### **LOCATION 125: PROGRAMMING FOR ZONE BYPASS REPORTING**

The Ranger 8980E has the ability to report a bypass on zones 1-8. The desired bypass code is programmed in location 125. If this location contains a "0", zone bypass will not be reported. When using 4+2 format, the number programmed in this location is sent as the "tens" digit. The "ones" digit is the zone communicator code. The bypass will be reported at the end of the exit delay for non-24 hour zones. 24 hour zones will report a bypass immediately. When a bypass is removed, a restore will be reported if "Restore" is enabled in location 126.

### **LOCATION 126: PROGRAMMING THE COMMUNICATOR CODE FOR RESTORAL**

Location 126 contains the communicator code that will be sent for restoral of a zone. If this location contains a "0", no restorals will be reported. If a restoral code is programmed and an extended format is selected, the restorals will be reported by zone. If a restoral code is programmed and an extended format is not selected, a restoral code will be sent when all of the previously reported conditions have restored. When using 4+2 format, the number programmed in this location is sent as the first, or "tens" digit. The second, or "ones" digit will be the "ones" digit of the zone or condition that restored.

### **LOCATION 127: PROGRAMMING THE COMMUNICATOR CODE FOR CANCEL (EXCEPTION OPENING)**

Location 127 contains the communicator code that will be sent for cancel. The cancel code programmed in this location will be sent if an arm/disarm code is entered after a trip on zones 1 through 8 has been reported (excluding 24 hour zones). After a cancel has been reported, no loop restorals will be transmitted on non-24 Hour zones. If this location contains a "0", cancel is disabled. When using 4+2 format, the number programmed in this location is sent as the "tens" digit. The "ones" digit is the man number of the person that canceled. When using a remote arming input, the man number is 1.

### **LOCATION 128: PROGRAMMING THE COMMUNICATOR TO ABORT**

Location 128 is used to enable the communicator abort. The number programmed in this location will be the number of two-second increments the 8980E will delay before attempting to communicate an alarm on a non-24 hour zone. If this location contains a "0", the Ranger 8980E will not abort any reports.

### **LOCATION 129: PROGRAMMING FOR SILENT PANIC/HOLD-UP**

Location 129 is used to silence the audible output for a panic/hold-up alarm. Programming a "1" in this location will silence the audible output during a panic/hold-up alarm. If this location contains a "0", the Ranger 8980E will have an audible panic/hold-up output. Program a "2" to silence Keypad Sounder during alarm.

### **LOCATION 130: ENABLING THE SWINGER SHUTDOWN**

Location 130 is used to enable the burglary zone swinger shutdown. The number programmed in this location, will determine the number of trips the Ranger 8980E will allow, before bypassing all burglary zones (1-8) which have tripped during an arming cycle. The bypassed zones will not report trips to a central station, and the local siren or bell will not sound for these zones. A zone trip will not be added to the number count until after the zone has tripped more than once. If this location contains a "0", this feature is disabled. A zone which has been bypassed by this feature will be reported if bypass reporting is enabled in location 125. **NOTE: THIS FEATURE CANNOT BE ENABLED FOR U.L. INSTALLATIONS.**

### **LOCATION 131: AUTOMATIC BYPASS / INSTANT ARMING**

Location 131 is used to enable automatic "Instant Arming". Programming a "1" in this location will cause the control to automatically enter the "Instant" mode and bypass interior follower zones if a fault is not detected on an entry/exit zone during the exit delay. Programming a "3" in this location (Automatic Bypass), will cause the interior follower zones to become bypassed if a fault is not detected on an entry/exit zone, yet will not change the status of the entry/exit zone. Programming a "4" in this location will enable Entry Guard (see page 27 for a complete description). If this location contains a "0", these features are disabled. Pressing the [\*] key when the system is armed, will cause the "Instant" light to toggle. When the "Instant" light is on, the entry/exit zone is instant; when off, the entry/exit zone is delayed. The [\*] key will toggle the "Instant" mode regardless of the programming data in this location. See location 141 "Special Keypad Functions" to further enhance these features.

### **LOCATION 132: SIREN DRIVER OR VOLTAGE OUTPUT / LAST CHANCE TO EXIT WARNING**

The built-in siren driver has a steady sound (for Priority zone type), and a yelp sound (for Burglary and Panic). Factory default is "0", enabling this feature. If the built-in siren driver is **NOT** to be used, take the following procedure. First, remove the jumper marked voltage/siren on the PC board. Next, program a "1" in location 132. Finally, replace the jumper in the voltage position. Terminals 21 & 22 will now output 1 Amp at 12VDC. NOTE: Ten seconds prior to the end of the exit delay the keypad will sound the "Last Chance To Exit Warning" (one long beep followed by three short beeps). To disable the "Last Chance To Exit Warning", add 4 to the Siren Driver/Voltage Output data selected above and program the sum (0 + 4 = "4" or 1 + 4 = "5") in this location.

### **LOCATION 133: L.E.D. EXTINGUISH FEATURE**

Keypad LEDs (with the exception of the A.C. LED) will be extinguished after 60 seconds of keypad inactivity, if a "1" is programmed in location 133. The LEDs will become illuminated immediately upon a keypress or alarm condition.

### **LOCATION 134: ENTERING THE NUMBER OF DIAL ATTEMPTS**

Location 134 is used to enter the number of dial attempts (1 to 15 attempts) the communicator will try for the appropriate phone number(s) before ending the notification process. If this location contains an "8", the communicator will make eight attempts to the first number, and then eight attempts to a second number, if a second number is programmed as backup.

### **LOCATION 135: POWER UP CONDITION**

If a "1" is programmed in location 135, the Ranger 8980E will power-up disarmed if there is a total power shutdown and battery failure. If a "2" is programmed in this location, it will power up armed. If this location contains a "0", the Ranger 8980E will maintain the condition it was in at power down. A watchdog circuit reset will cause the Ranger 8980E to reset to the selected condition.

### **LOCATION 136: POWER UP DELAY**

If a "1" is programmed in location 136, the Ranger 8980E will not delay 60 seconds before accepting open or short inputs from any zone. If a "0" is programmed, sensors on all zones are allowed 60 seconds to stabilize at power-up.. After 60 seconds, the Ranger will once again accept loop opens or shorts as an alarm condition. This 60 second period will also be initiated after exiting the program mode, or a watchdog circuit reset condition.

### **LOCATION 137: IMMEDIATE RESTORE BY ZONE**

If a "1" is programmed in location 137, restoral signals will follow the restore condition and report restores immediately after the condition has unfaulted. A non-extended format will not send a restore message until all zones and trouble conditions have restored. If this location contains a "0", the restore signal or signals will be reported only after siren timeout.

### **LOCATION 138: NO ARMING WITH A ZONE BYPASSED**

If a "1" is programmed in location 138, the Ranger 8980E will not arm with any zone bypassed. If programmed with a "0", up to 7 of the 8 burglary zones can be bypassed, and the Ranger 8980E can still be armed. If an "8" is programmed in Location 138, the Ranger 8980E will not initiate the Keypad Sounder when either armed or disarmed without AC power.

### **LOCATION 139: PROGRAMMING THE QUICK ARM DIGIT**

Location 139 contains the "Quick Arm" digit. To enable, program a digit (1-9) in this location. If the "Quick Arm" digit is the same as the first digit of the Master code (user 1), the "Chime" feature will not function. The "Quick Arm" digit cannot be the same as the first digit of the "Go To Program" code. Default is "0", disabled.

### **LOCATION 140: PRIORITY SIREN CUTOFF INHIBIT**

If a "1" is programmed in location 140, a Priority zone type siren will sound continuously until an arm/disarm code is entered. If this location contains a "0", the Priority zone type siren will shutdown after the amount of time programmed in location 077 has elapsed. Programming in this location does not affect the burglary siren.

### **LOCATION 141: SPECIAL KEYPAD COMMAND FUNCTIONS**

When the system is armed and this location is programmed with something other than a "0", pressing the first digit of the Master code followed immediately by the [\*] key can create one or more of the changes described below. Select the desired features from the table below, add their values, and program the sum in location 141.

VALUE	DESCRIPTION
1	Restart The Exit Delay.
2	Make Interior Delay Zones Bypass & Unbypass Like Interior Follower Zones During Automatic Bypass / Instant Arming Conditions (location 131).
4	Unbypass All Bypassed Interior Zones.
8	Convert Remote Arming Pins On PCB To A Remote Keypad Panic Zone. (Must be normally open momentary panic switch)

### **LOCATION 142: SIREN/BELL TEST FEATURE**

The siren/bell can be programmed to activate upon different conditions. Using the chart below, add the values of the desired condition(s) and program the sum of those values in location 142. When the siren/bell is activated by pressing the [1] and [7] keys simultaneously, the communicator will not report a message, and the siren/bell can be silenced by entering an arm/disarm code.

VALUE	DESCRIPTION
1	Activation by pressing [1] and [7] keys simultaneously
2	Momentary activation at arming
4	Momentary at end of exit delay
8	Momentary at kiss off ringback

### **LOCATION 143: SMOKE POWER RESET AND/OR FIRE ALARM VERIFICATION**

Programming a "1" in location 143 will cause the 8980E (when in the disarmed state) to interrupt the smoke detector power each time the [#] button is pressed. If this location contains a "0", the smoke detector power will reset only after the [#] button is pressed when the corresponding LED(s) for zones designated as "Priority" are on steady for alarm or blinking for trouble. Programming a "2" in this location will enable the "Fire Alarm Verification" feature. When the "Fire Alarm Verification" feature is enabled, a smoke detector will be powered down and reset automatically after the first trip, waiting for a second trip within a 2 minute time frame (thus verifying a fire alarm condition) before creating an alarm and communicating a message.

### **LOCATION 144: EUROPEAN PULSE DIAL RATIO**

Programming a "1" in location 144 will change the pulse dialing make/break ratio and interdigit spacing to conform



to most European telecom standards.

**LOCATION 145-148: PROGRAMMING THE AUXILIARY OUTPUTS**

Four of the functions in the following table are available on terminals 1 thru 4. These outputs are often used to switch small relays, LED's, trip long range radio, or to add a remote sensor. For example, to create an LED that lights for alarm memory, program an "11" into location 145. Wire the positive lead of the LED to terminal 26 (positive aux power) and the negative lead through a limiting resistor of approximately 650 ohms to terminal 1 (aux output 1). If the LED operation is "ON" when you want it to be "OFF", see location 149. **NOTE: NO MORE THAN 20 MILLIAMPS CAN BE SUPPLIED FROM THESE TERMINALS.** (250 MICROAMPS IF POSITIVE)

DATA	ACTIVATION ON	NOTES
"0"	BURGLARY ALARM	MOMENTARY OUTPUT *
"1"	FIRE ALARM	MOMENTARY OUTPUT *
"2"	PANIC ALARM / DURESS	MOMENTARY OUTPUT *
"3"	ARMED STATE	LATCHED OUTPUT
"4"	ARMED WITH BYPASS	LATCHED OUTPUT
"5"	AC POWER	LATCHED OUTPUT
"6"	LOW BATTERY	LATCHED OUTPUT
"7"	LISTEN IN	MOMENTARY OUTPUT
"8"	TAMPER ALARM	LATCHED OUTPUT
"9"	AUTOTEST	MOMENTARY OUTPUT
"10"	PHONE FAULT	LATCHED OUTPUT
"11"	ALARM MEMORY	LATCHED OUTPUT
"12"	ENTRY/KEYPAD SOUNDER **	LATCHED OUTPUT
"13"	EXIT	LATCHED OUTPUT
"14"	STATUS LED	LATCHED OUTPUT
"15"	GROUND START	MOMENTARY OUTPUT

\* The Fire, Panic, Burglary options for the auxiliary outputs can be programmed for momentary, or to follow the siren. Programming a "2" in location 132 will activate the auxiliary outputs when these events occur. Programming a "0" in location 132 will cause the Burglary and Panic outputs to activate when the yelping siren is on and the Fire auxiliary output to activate when the steady siren is on.

\*\* See Location 243

**LOCATIONS 149: INVERTING THE AUXILIARY OUTPUTS**

Auxiliary outputs are normally "OFF", and turn "ON" when the selected condition occurs. For outputs you wish to reverse, add up their values according to the following chart and program the sum in this location. For example, to reverse outputs 2 and 3, program a "6" (2 + 4 = "6") in location 149.

VALUE	DESCRIPTION
1	Invert auxiliary 1 output
2	Invert auxiliary 2 output
4	Invert auxiliary 3 output
8	Invert auxiliary 4 output

**LOCATION 150: AC POWER LOSS DELAY FEATURE**

Location 150 contains the number of two minute delays (two to fourteen minutes) the communicator will wait before reporting an AC power failure. A "1" programmed in this location will create a two minute delay, and a "7" will create a fourteen minute delay. If a "0" is programmed in this location, AC power failures will be reported immediately if AC power loss reporting is enabled in locations 120-121. **NOTE: Do not program a number higher than "7" in this location.**

### **LOCATION 151: PROGRAMMING THE NUMBER OF RINGS TO ANSWER DOWNLOAD CALL**

Location 151 contains the number of rings the 8980E must detect before answering the telephone when initiating a download. If a number from "1" to "15" is programmed in this location, the control will answer after **THIS** number of rings has been detected. If a "0" is programmed in this location, the 8980E will not answer the download call. Pressing[\*]-[9]-[#] on the keypad while the phone is ringing will cause the control panel to answer the call immediately, if the system is in the disarmed state. (SEE LOCATION 196 or 280: ANSWERING MACHINE DEFEAT)

### **LOCATION 152: PROGRAMMING THE NUMBER OF DAYS LEFT UNTIL AUTOTEST REPORT**

Location 152 contains the number of days left until the next autotest report. If this location contains a "0", an autotest signal will be reported the first time the current time equals the autotest time programmed in locations 162-165. Locations 098-099 must be programmed to enable autotest reporting.

### **LOCATION 153: PROGRAMMING THE CLOCK, CURRENT MONTH**

Location 153 contains the current month. The month must be programmed using a number from "1" to "12". This location must be programmed when using the maintenance code feature (see location 167).

### **LOCATION 154: PROGRAMMING THE CLOCK, CURRENT YEAR - TENS DIGIT**

Location 154 contains the current year - tens digit. If the current year is 1994, this location should contain a 9, which is the tens digit of the current year.

### **LOCATION 155: PROGRAMMING THE CLOCK, CURRENT YEAR - ONES DIGIT**

Location 155 contains the current year - ones digit. If the current year is 1994, this location should contain a "4", which is the ones digit of the current year. If the current year is 1995, this location should contain a "5", which is the ones digit of the current year.

### **LOCATION 156: PROGRAMMING THE CLOCK, CURRENT DAY OF THE MONTH - TENS DIGIT**

Location 156 contains the current day of the month - tens digit. If the current day of the month is the 5th (05), this location should contain a "0", which is the current day of the month - tens digit. If the current day of the month is the 26th, this location should contain a "2".

### **LOCATION 157: PROGRAMMING THE CLOCK, CURRENT DAY OF THE MONTH - ONES DIGIT**

Location 157 contains the current day of the month - ones digit. If the current day of the month is the 5th (05), this location should contain a "5", which is the current day of the month - ones digit. If the current day of the month is the 26th, this location should contain a "6".

### **LOCATION 158: PROGRAMMING THE CLOCK, CURRENT HOUR - TENS DIGIT**

Location 158 contains the current hour - tens digit. The time is entered in 24 hour time. If the current time is 5:25 PM, the 24 hour time is 17:25, so this location should contain a "1", which is the current hour - tens digit. If the current time is 9:36 AM, the 24 hour time is 09:36, so this location should contain a "0".

### **LOCATION 159: PROGRAMMING THE CLOCK, CURRENT HOUR - ONES DIGIT**

Location 159 contains the current hour - ones digit. The time is entered in 24 hour time. If the current time is 5:25 PM, the 24 hour time is 17:25, so this location should contain a "7", which is the current hour - ones digit. If the current time is 9:36 AM, the 24 hour time is 09:36, and this location should contain a "9".

#### **LOCATION 160: PROGRAMMING THE CLOCK, CURRENT MINUTES - TENS DIGIT**

Location 160 contains the current minutes - tens digit. The time is entered in 24 hour time. If the current time is 5:25 PM, the 24 hour time is 17:25, so location 160 should contain a "2", which is the current minutes - tens digit. If the current time is 9:36 AM, the 24 hour time is 09:36, and this location should contain a "3".

#### **LOCATION 161: PROGRAMMING THE CLOCK, CURRENT MINUTES - ONES DIGIT**

Location 161 contains the current minutes - ones digit. The time is entered in 24 hour time. If the current time is 5:25 PM, the 24 hour time is 17:25, so this location should contain a "5", which is the current minutes - ones digit. If the current time is 9:36 AM, the 24 hour time is 09:36, and this location should contain a "6".

#### **LOCATION 162: PROGRAMMING THE AUTOTEST TIME, HOUR - TENS DIGIT**

Location 162 contains the tens digit of the hour that the autotest report is initiated. The time is entered in 24 hour time. If the desired autotest time is 5:25 PM, the 24 hour time is 17:25, so this location should contain a "1", which is the tens digit of the desired hour for autotest. If the desired autotest time is 9:36 AM, the 24 hour time is 09:36, and this location should contain a "0".

#### **LOCATION 163: PROGRAMMING THE AUTOTEST TIME, HOUR - ONES DIGIT**

Location 163 contains the ones digit of the hour that the autotest report is desired. The time is entered in 24 hour time. If the desired autotest time is 5:25 PM, the 24 hour time is 17:25, so this location should contain a "7", which is the ones digit of the hour for autotest. If the desired autotest time is 9:36 AM, the 24 hour time is 09:36, and this location should contain a "9".

#### **LOCATION 164: PROGRAMMING THE AUTOTEST TIME, MINUTES - TENS DIGIT**

Location 164 contains the tens digit, of the minutes after the hour that the autotest is desired. The time is entered in 24 hour time. If the desired autotest time is 5:25 PM, the 24 hour time is 17:25, so this location should contain a "2", which is the tens digit of the minutes for autotest time. If the desired autotest time is 9:36 AM, the 24 hour time is 09:36, this location should contain a "3".

#### **LOCATION 165: PROGRAMMING THE AUTOTEST TIME, MINUTES - ONES DIGIT**

Location 165 contains the ones digit, of the minutes after the hour that the autotest is desired. The time is entered in 24 hour time. If the desired autotest time is 5:25 PM, the 24 hour time is 17:25, so this location should contain a "5", which is the ones digit of the minutes for autotest time. If the desired autotest time is 9:36 AM, the 24 hour time is 09:36, and this location should contain a "6".

#### **LOCATION 166 PROGRAMMING THE AUTOTEST TIME REPORTING INTERVALS**

Location 166 contains the number of days between automatic test reports. If a report is desired every 7 days, this location should contain a "7". Valid entries are "1" to "15" days.

#### **LOCATION 167: PROGRAMMING FOR ROTATING MAINTENANCE CODES**

The Ranger 8980E has the ability to automatically generate a different MAINTENANCE arm/disarm code daily. This code is produced using the current date programmed in locations 153-157, and the 4 digit complex or "seed code", programmed in locations 168-171. This code can then be generated by using the CG-800 "Code Generating Software", which is designed to operate on a DOS based personal computer. If this location contains a "1", the maintenance code is enabled and the code will change daily. If this location contains a "3", the code will change on the first day of each month. If location 167 contains a "0", this feature is disabled, and the user #7 arm/disarm code will be the code programmed in locations 024-027. **NOTE:** Activating the maintenance code will automatically disable the duress code, regardless of what is programmed in locations 086-087. **NOTE: FOR U.L. GRADE A INSTALLATIONS, THIS FEATURE SHALL BE DISABLED.**

**LOCATION 168-171: PROGRAMMING THE SEED CODE FOR ROTATING MAINTENANCE CODES**

Locations 168-171 contain the complex, or "seed code" required to generate rotating maintenance codes as described in the paragraph above. These locations allow a unique set of codes for different buildings or complexes. NOTE: ACTIVATING THE MAINTENANCE CODE WILL AUTOMATICALLY DISABLE THE DURESS CODE, REGARDLESS OF WHAT IS PROGRAMMED IN LOCATIONS 086-087.

**LOCATION 172: PROGRAMMING USER 7 OR MAINTENANCE CODE OPENING COMMUNICATOR CODE**

The Ranger 8980E has the ability to give an opening report each time user number 7 disarms the control. The desired opening code should be programmed in this location. This feature can be used in conjunction with the rotating maintenance code to give an opening report each time the maintenance code is used to disarm. When using an extended format, the extended code will always be a 7.

**LOCATION 173: PROGRAMMING USER 7 OR MAINTENANCE CODE CLOSING COMMUNICATOR CODE**

The Ranger 8980E has the ability to give a closing report each time user number 7 arms the control. The desired closing code should be programmed in this location. This feature can be used in conjunction with the rotating maintenance code to give a closing report each time the maintenance code is used to arm. When using an extended format, the extended code will always be a 7. CAUTION! If a "Quick Arm" code has been selected, and the first digit of the rotating maintenance code is the same digit as the "Quick Arm" code, the maintenance closing code will not be reported.

**LOCATION 174: PROGRAMMING ZONES 3 THRU 6 FOR NORMALLY CLOSED OPERATION ONLY**

Location 174 is used to program zones 3,4,5,& 6 for normally closed operation only, eliminating the need for the end of line resistors on that zone. When a zone is programmed for normally closed operation only, a short will not change the loop condition, and an open on that zone will produce a faulted condition. This feature will be ignored by any Priority zone. To program a zone for normally closed only, refer to the chart below, and program the appropriate data in this location. NOTE: FOR U.L. GRADE A INSTALLATIONS, ALL ZONES MUST BE PROGRAMMED AS SUPERVISED.

<b>ZONES TO PROGRAM FOR N/C OPERATION</b>	<b>DATA TO PROGRAM IN LOCATION 174</b>
6	"1"
5	"2"
5 & 6	"3"
4	"4"
4 & 6	"5"
4 & 5	"6"
4, 5, & 6	"7"
3	"8"
3 & 6	"9"
3 & 5	A ="10"
3, 5, & 6	B ="11"
3 & 4	C ="12"
3, 4, & 6	D ="13"
3, 4, & 5	E ="14"
3, 4, 5, & 6	F ="15"

**LOCATION 175: PROGRAMMING ZONES 1,2,7, & 8 FOR NORMALLY CLOSED OPERATION ONLY**

Location 175 is used to program zones 1,2,7, & 8 for normally closed operation only, eliminating the need for the end of line resistors on these zones. When a zone is programmed for normally closed operation, a short on that zone will not change the loop condition, and an open on that zone will produce a faulted condition. This feature will be ignored by any Priority zone. To program a zone for normally closed only, refer to the chart on the following page, and program the appropriate data in this location. NOTE: FOR U.L. GRADE A INSTALLATIONS, ALL ZONES MUST BE PROGRAMMED AS SUPERVISED.

ZONES TO PROGRAM FOR N/C OPERATION	DATA TO PROGRAM IN LOCATION 175
2	"1"
1	"2"
2 & 1	"3"
7	"4"
7 & 2	"5"
7 & 1	"6"
7, 2, & 1	"7"
8	"8"
8 & 2	"9"
8 & 1	A = "10"
8, 2, & 1	B = "11"
8 & 7	C = "12"
8, 7, & 2	D = "13"
8, 7, & 1	E = "14"
8, 7, 1, & 2	F = "15"

**LOCATION 176: SPLIT REPORTING - PROGRAMMING TAMPER, DOWNLOAD COMPLETE, AND AUTOTEST TO REPORT TO THE SECONDARY PHONE NUMBER**

The 8980E is capable sending certain reports to the secondary telephone number. This feature known as split reporting can be used to send alarm reports to one number and supervisory reports to another number. When using split reporting with the 8980E, the primary telephone number always takes priority over the secondary telephone number. The 8980E always sends zone and alarm reports to the primary telephone number. There are 7 reports that can be programmed to report to the second telephone number. Location 176 is used to force up to three of these individual reports to the second telephone number. To program tamper, download complete, or autotest to report to the secondary telephone number, use the following chart and program the appropriate number in location 176. For Dual Reporting see locations 204-206.

REPORTS TO SEND TO SECONDARY NUMBER	DATA TO PROGRAM IN LOCATION 176
AUTOTEST	"2"
DOWNLOAD COMPLETE	"4"
DOWNLOAD COMPLETE ; AUTOTEST	"6"
TAMPER	"8"
TAMPER ; AUTOTEST	A = "10"
TAMPER ; DOWNLOAD COMPLETE	C = "12"
TAMPER ; DOWNLOAD COMPLETE ; AUTOTEST	E = "14"

**LOCATION 177: SPLIT REPORTING - PROGRAMMING AC POWER FAIL, LOW BATTERY, OPEN/CLOSE, AND MAINTENANCE OPEN/CLOSE TO REPORT TO THE SECONDARY PHONE NUMBER**

The 8980E is capable sending certain reports to the secondary telephone number. This feature known as split reporting can be used to send alarm reports to one number, and supervisory reports to another number. When using split reporting with the 8980E, the primary telephone number always takes priority over the secondary number. The 8980E always sends zone and alarm reports to the primary number. There are 7 reports that can be programmed to report to the second telephone number. Location 177 is used to force up to four of these individual reports to the second number. To program AC power fail, low battery, open/close, or maintenance code open/close to report to the secondary number, use the following chart and program the appropriate data in this location.

REPORTS TO SEND TO SECONDARY NUMBER	DATA FOR LOCATION
MAINT CODE OPEN/CLOSE	"1"
OPEN/CLOSE	"2"
OPEN/CLOSE; MAINT CODE OPEN/CLOSE	"3"
LOW BATTERY	"4"
LOW BATTERY; MAINT CODE OPEN/CLOSE	"5"
LOW BATTERY; OPEN/CLOSE	"6"
LOW BATTERY; OPEN/CLOSE; MAINT CODE OPEN/CLOSE	"7"
AC FAIL	"8"
AC FAIL; MAINT CODE OPEN/CLOSE	"9"
AC FAIL; OPEN/CLOSE	A ="10"
AC FAIL; OPEN/CLOSE; MAINT CODE OPEN/CLOSE	B ="11"
AC FAIL; LOW BATTERY	C ="12"
AC FAIL; LOW BATTERY; MAINT CODE OPEN/CLOSE	D ="13"
AC FAIL; LOW BATTERY; OPEN/CLOSE	E ="14"
AC FAIL; LOW BATTERY; OPEN/CLOSE; MAINT CODE OPEN/CLOSE	F ="15"

**LOCATION 178: PROGRAMMING THE SECONDARY ENTRY DELAY (ZONE TYPE 9)**

Location 178 contains the number of 10 second increments in the secondary entry delay. This delay can be programmed from 10 to 150 seconds ("1" = 10 sec thru "15" = 150 sec). NOTE: ACCORDING TO SEC. 26 OF U.L. 1023, THE SECONDARY ENTRY TIME SHALL NOT EXCEED 45 SECONDS.

**LOCATION 179: PROGRAMMING THE SECONDARY EXIT DELAY (ZONE TYPE 9)**

Location 179 contains the number of 10 second increments after arming, before trips will be recognized on a zone type 9. The exit delay can be programmed in 10 second increments from 10 to 150 seconds ("1" = 10 seconds thru "15" = 150 seconds). (Note: A "0" entry is treated as zero (0) seconds). If the exit delay time in this location is less than that of location 076, this secondary delay will follow the amount of time in location 076. NOTE: ACCORDING TO SEC. 26 OF U.L. 1023, THE SECONDARY EXIT TIME SHALL NOT EXCEED 60 SECONDS.

**LOCATION 180: PROGRAMMING THE LOOP RESPONSE TIME**

Location 180 is used to program the loop response time for all zones programmed as fast loop response in locations 186-193. The response time is equal to 20 milliseconds times the number programmed in this location ("1" = 20 milliseconds and "5" = 100 milliseconds). If this location contains a "0", the loop response time will be 500 milliseconds.

### **LOCATION 181: PROGRAMMING FOR HOURLY AUTOTEST / AUTO-SET CLOCK**

Location 181 can be used to activate several different conditions. Using the chart below, add the values of the desired activations and program the sum of those values in location 181. Factory default is "0" disabled.

VALUE	DESCRIPTION
1	Autotest reports will be suppressed if the communicator has sent a report since the last Autotest.
2	Autotest in hourly increments and reset hourly timer when a communication is sent to the receiver.
4	Call download computer to reset clock after power down.
8	Call download computer after power up or watchdog reset.

### **LOCATION 182: FORMAT OVER-RIDE LOCATION**

The number selected in this location will select the format options as follows:

VALUE	DESCRIPTION
1	Add for extended reporting
2	Add for hex digits allowed
4	Add for 20PPS
8	Add for 10PPS

### **LOCATION 183: FORMAT OVER-RIDE LOCATION**

The number selected in this location will select the format options as follows:

VALUE	DESCRIPTION
1	Add for 1800hz transmit
2	Add for 2300hz handshake
4	Add for single round parity
8	Add for 2 digit event code

### **LOCATIONS 184-185: RESERVED LOCATIONS**

### **LOCATIONS 186-193: ASSIGNING SPECIAL CHARACTERISTICS FOR ZONES 1-8**

Locations 186-193 are used to assign individual characteristics for each of zones 1-8. These locations can be used to enable or disable the chime feature, restore reporting, bypass feature, and fast loop response for each of the individual zones 1-8. To enable the features, enter a binary number according to the following chart:

VALUE	SPECIAL CHARACTERISTICS
1	Fast loop response time (see location 180)
2	Bypass Capability
4	Zone Restoral Reporting
8	Chime enable

### **LOCATION 194: TELEPHONE LINE FAULT MONITOR**

A "1" in this location will activate the siren, a "2" will activate the keypad sounder, and a "3" will activate both any time a phone line fault is detected. A "9" will activate the siren, a "10" will activate the keypad sounder, and an "11" will activate both, if a line fault is detected only while the system is armed. If a "10" or "11" is selected, Keypad Sounder will sound when system is disarmed. The green "Ready" LED will flash upon detection of a phone line fault if this feature is selected. Factory default is "0" (disabled).

### **LOCATION 195: TELEPHONE LINE FAULT DELAY**

Location 195 is used to program a delay of sounder activation after a phone line fault has been detected. Programmable in 10 second increments, a "1" thru "15" will cause a delay of 10 to 150 seconds. If a "0" is programmed in this location the activation will be instant. If a "6" is programmed in this location the activation will be delayed 60 seconds.

**LOCATION 196: ANSWERING MACHINE DEFEAT**

Location 196 contains the answering machine defeat. To defeat an answering machine, two telephone calls must be made to the premises. On the first call, let the phone ring the same number of times (or less) as the number programmed in this location (maximum 3) and disconnect. The control panel will detect these rings and start a 45 second timer, during which, the control panel will answer the next call on the first ring. This location will override location 280 if it contains something other than a "0" (factory default).

**LOCATION 197: FORCE ARMING**

Force Arming is a feature that will allow the Ranger 8980E to be armed without all zones secure (no "Ready" LED illuminated). At the end of the exit delay, all unsecured zones will automatically bypass, while all secure (Ready) zones will be armed and active in the system. Factory default is "0", Force Arming disabled. Program a "1" to enable Force Arming. In either case, all zones (excluding 24 hour zones) will be delayed during the exit delay. Force Arming shall be disabled ("0") for UL Listed systems.

**NOTE:** All zones (excluding 24 hour zones) are delayed during the exit delay time. Programming a "2" in this location will make Instant zones "Instant" during the exit delay time.

**LOCATIONS 198-201: AUTOMATIC ARMING TIME**

Locations 198-201 contain the time for automatic arming if enabled in location 202. Enter the time in 24 hour (military) time.

**LOCATION 202: AUTOMATIC ARMING**

Programming a "1" in location 202 will enable Automatic Arming. The arming time is programmed in location 198-201. If Automatic Arming is enabled, the keypad sounder will activate for 50 seconds before automatically arming. If the sounder is silenced by entering a valid arm/disarm code during the 50 second time frame, the panel will not arm. If the sounder is still on at the end of 50 seconds, the control will arm. Any zones not secured will be bypassed when Automatic Arming is used. Note: This feature shall be disabled for U.L. listed systems.

**LOCATION 203: DYNAMIC BATTERY TEST**

The number programmed in location 203 determines the number of minutes (1 to 15) the 8980E will perform Dynamic Battery testing during each 24 hour period. The red "Power" LED will flash if the battery fails the Dynamic Battery Test. Factory default is "0" (disabled). **NOTE:** The clock must be set (locations 153-161) for Dynamic Battery Test to function.

**LOCATION 204: DUAL REPORTING - PROGRAMMING TAMPER, DOWNLOAD COMPLETE, AND AUTOTEST TO REPORT TO THE BOTH PHONE NUMBERS**

The 8980E is capable of sending certain reports to both the primary and secondary phone numbers. When using dual reporting, the primary phone number always takes priority over the secondary number. There are 7 reports that can be individually programmed to report to both phone numbers. Location 204 is used to force up to three of these individual reports to both numbers. To program tamper, download complete, or autotest to report to both numbers, use the following chart and program the appropriate data in location 204.

<b>REPORT TO BOTH PHONE NUMBERS</b>	<b>DATA TO PROGRAM IN LOCATION 204</b>
AUTOTEST	"2"
DOWNLOAD COMPLETE	"4"
DOWNLOAD COMPLETE ; AUTOTEST	"6"
TAMPER	"8"
TAMPER ; AUTOTEST	A = "10"
TAMPER ; DOWNLOAD COMPLETE	C = "12"
TAMPER ; DOWNLOAD COMPLETE ; AUTOTEST	E = "14"



**LOCATION 205: DUAL REPORTING - PROGRAMMING AC POWER FAIL, LOW BATTERY, OPEN/CLOSE, AND MAINTENANCE OPEN/CLOSE TO REPORT TO THE PRIMARY AND SECONDARY PHONE NUMBERS**

The 8980E is capable of sending certain reports to both the primary and secondary phone numbers. When using dual reporting, the primary number always takes priority over the secondary number. There are 7 reports that can be programmed to report to both numbers. Location 205 is used to force up to four of these individual reports to both phone numbers. To program AC power fail, low battery, open/close, or maintenance code open/close to report to both numbers, use the following chart and program the appropriate data in this location.

REPORTS TO SEND TO BOTH PHONE NUMBERS	DATA FOR LOCATION
MAINT CODE OPEN/CLOSE	"1"
OPEN/CLOSE	"2"
OPEN/CLOSE; MAINT CODE OPEN/CLOSE	"3"
LOW BATTERY	"4"
LOW BATTERY; MAINT CODE OPEN/CLOSE	"5"
LOW BATTERY; OPEN/CLOSE	"6"
LOW BATTERY; OPEN/CLOSE; MAINT CODE OPEN/CLOSE	"7"
AC FAIL	"8"
AC FAIL; MAINT CODE OPEN/CLOSE	"9"
AC FAIL; OPEN/CLOSE	A = "10"
AC FAIL; OPEN/CLOSE; MAINT CODE OPEN/CLOSE	B = "11"
AC FAIL; LOW BATTERY	C = "12"
AC FAIL; LOW BATTERY; MAINT CODE OPEN/CLOSE	D = "13"
AC FAIL; LOW BATTERY; OPEN/CLOSE	E = "14"
AC FAIL; LOW BATTERY; OPEN/CLOSE; MAINT CODE OPEN/CLOSE	F = "15"

**LOCATION 206: ALL REPORTS TO BOTH THE PRIMARY AND SECONDARY PHONE NUMBERS**

Programming a "1" in location 206 will cause the 8980E to send all reports to both the primary and secondary telephone numbers.

**LOCATION 207: CALLBACK PHONE NUMBER CONTROL**

The number programmed in location 207 controls the use of the callback telephone number. The callback number must be programmed in the download section for this location to have an effect. The callback number will be used according to the following binary scale:

VALUE	DESCRIPTION
1	Add if a callback should not occur before a download session
2	Add if [*]-[8]-[#] sight initiated download is enabled
4	Add if callback at autotest intervals is enabled
8	Add for automatic callback when event log is full

### **LOCATION 208: FORMAT OVER-RIDE LOCATION**

The number programmed in this location will select the available format options. NOTE: You must use DTMF transmission for the Pager format to function (see location 209 below).

VALUE	DESCRIPTION
1	Add for Pager format
2	Add for Ademco Handshake
4	Add for Caddx modem
8	Add for Sescoa Superfast

### **LOCATION 209: FORMAT OVER-RIDE LOCATION**

The number programmed in this location will select the available format options. NOTE: You must use DTMF transmission for the Pager format to function.

VALUE	DESCRIPTION
1	Add for Contact ID
2	Add for SIA
4	Add for 4 + 3
8	Add for DTMF transmission

### **LOCATION 210: PROGRAMMING TO REPORT EXIT ERROR**

The Ranger 8980E has the ability to report an exit error code if an entry/exit zone is violated at the moment the exit delay expires. The desired exit error code is programmed in location 210. If this location contains a "0", exit errors will not be reported. When using 4+2 format, the number programmed in this location is sent as the "tens" digit. The "ones" digit is automatically the man number. When using the remote arming input, the man number is 1. When using a one button "Quick Arm" code the man number is 1.

### **LOCATION 211: PROGRAMMING TO REPORT RECENT CLOSING**

The Ranger 8980E has the ability to report a recent closing code if an alarm occurs within 5 minutes of a closing. The desired recent closing code is programmed in location 211. If this location contains a "0", recent closings will not be reported. When using 4+2 format, the number programmed in this location is sent as the "tens" digit. The "ones" digit is automatically the man number. When using the remote arming input, the man number is 1. When using a one button "Quick Arm" code the man number is 1. When using auto-arm, the man number is 9.

### **LOCATIONS 212-239: PROGRAMMING THE ARM/DISARM CODES FOR USERS 8-14**

Locations 212-239 contain the arm/disarm codes for user numbers 8-14. These codes can be accessed only in the program mode, or through downloading.

### **LOCATION 240: ENTERING THE NUMBER OF DIAL ATTEMPTS TO SECONDARY PHONE NUMBER**

Location 240 is used to enter the number of dial attempts (1 to 15 attempts) the communicator will try to the second phone number before ending the notification process. If this location contains an "8", the communicator will make 8 attempts to the second number, if a second number is programmed. If this location contains a "0", the number programmed in location 134 will be used.

### **LOCATION 241-LISTEN-IN TIME**

Location 241 is used to program Listen-In time in 30 second increments. Valid entries are 1-3 (1=30, 3=90).

### **LOCATION 242 - RESERVED**

### **LOCATION 243 - ENTRY / KEYPAD SOUNDER**

In Location 243, program an "8" to make a DATA entry of "12" in location 145-148 become an "ENTRY SOUNDER".

## **LOCATIONS 244-251: ASSIGNING SPECIAL CHARACTERISTICS FOR ZONES 1-8**

Locations 244-251 are used to assign individual characteristics for each of zones 1-8. These locations can be used to enable or disable the Trouble Reporting, Group Bypass, Entry-Guard, and Cross Zone feature for each of the individual zones 1-8. To enable these features, enter a binary number according to the following chart:

VALUE	DESCRIPTION
1	Cross Zone
2	Entry Guard Zone
4	Group Bypass Zone
8	Trouble Reporting

**CROSS ZONING** - This feature requires a trip on 2 or more zones programmed as Cross Zones within the time frame programmed in Location 255 (1-15 minutes). It is important that at least 2 zones be programmed for cross zoning if this feature is to be used. First zone trip will initiate the keypad sounder, second zone trip creates an alarm. Either can be silenced by entering a valid code.

**ENTRY GUARD** - An addition to modes described in location 131. Enable by adding "4" to the number programmed in location 131. When enabled, all non Entry-Guard zones will be bypassed and all other zones will be delayed when the "Instant" LED is activated. When the "Instant" LED is off, all non bypassed zones will resume their normal characteristics. The Entry-Guard feature is activated by pressing the [\*] key during the exit delay.

**GROUP BYPASSING** - This feature will allow all zones programmed as group bypass zones to be bypassed by entering [\*]-[9]-[\*] when the control is disarmed.

### **LOCATION 252-253: PROGRAMMING TO REPORT KEYPAD AUXILIARY 3**

The Ranger 8980E has the ability to report a Silent Auxiliary 3 code each time the [7] and [9] keys are pressed simultaneously on the keypad. The desired Auxiliary 3 code is programmed in locations 252-253. If both locations are "0", the Auxiliary 3 double keypress is disabled. Location 252 contains the standard digit, and location 253 contains the extended digit. When using 4+2 format, the number programmed in location 252 is sent as the "ones" digit. The "tens" digit is programmed in location 253.

### **LOCATION 254: PROGRAMMING TO "USER ON SITE"**

The 8980E has the ability to send a "user on site" report by entering [\*]-[0], followed by a valid arm/disarm code at the keypad when the system is not armed. This can be used to log the return of latch key kids or the presence of employees. The desired "user on site" code is programmed in location 254. If this location contains a "0", "user on site" report will not be sent. When using 4+2 format, the number programmed in this location is sent as the "tens" digit. The "ones" digit is automatically the man number. When using the remote arming input, the man number is 1. When using a one button "Quick Arm" code the man number is 1.

### **LOCATION 255: PROGRAMMING THE CROSS ZONE TIME**

Location 255 contains the number of minutes (1 to 15) in which a second trip must occur in a cross zone before an alarm is created. Care must be taken when activating this feature that two or more cross zones are set up that will be tripped within this time frame in the event of a burglary. This feature should only be used on interior zones. Never activate cross zoning on a perimeter zone.

## **THE REMAINING LOCATIONS ARE ACCESSIBLE ONLY THROUGH DOWNLOADING !**

### **LOCATIONS 256-263: CONTROL PANEL ACCESS CODE**

Locations 256-263 contain the eight digit access code the 8980E must receive from the downloading software before the panel will permit downloading to occur. The factory default code is listed in the instructions provided with the CADDX download software package.

### **LOCATIONS 264-279: CALL BACK TELEPHONE NUMBER**

The presence of a phone number in locations 264-279 will cause the control panel to dial back this number after a successful panel access code has been entered. If a telephone number is present, the control panel will hang up for approximately 36 seconds (insuring that the calling party has disconnected), then it will call back. Any zero (0) within the telephone number must be programmed as an "A". If tone dialing is desired, program an "F" in the location where tone dialing should begin. If the entire number should be tone dialing, program an "F" in location 264. Four second delays can be obtained anywhere in the sequence by programming a "D" in the appropriate delay location. **WARNING: THE CALLBACK PHONE NUMBER SHOULD ALWAYS BE REVIEWED FOR ACCURACY BEFORE DISCONNECTING.**

### **LOCATION 280: ANSWERING MACHINE DEFEAT**

Location 280 contains the answering machine defeat enable. To defeat an answering machine, two telephone calls must be made to the premises. On the first call, let the phone ring the same number of times (or less) as the number programmed in this location (maximum 3). The control panel will detect these rings and start a 45 second timer. If a call comes in during that 45 second time frame, the control panel will answer on the first ring. To disable this feature, program a "0" in this location. **NOTE:** If anything is programmed in location 196, it will override this location.

### **LOCATION 281: LOCAL PROGRAMMING LOCKOUT**

Location 281 is used to disable local programming lockout. If a "5" is programmed in this location, all local programming is locked out. If an "A" is programmed in this location, all programming functions related to the digital communicator will be locked out. Any other number in location 281 will allow all local programming.

### **LOCATION 282: CONTROL PANEL SHUTDOWN**

Location 282 is used to shut down the control panel. Programming an "A" in this location will completely shutdown the control panel. The keypad will appear "dead", and the siren and communicator will not operate. **WARNING: EXTREME CARE SHOULD BE TAKEN NOT TO INADVERTENTLY PROGRAM THIS LOCATION.**

## **ADDITIONAL COMMENTS ABOUT THE 8980E**

1. The Fire, Panic, Burglary options for the auxiliary outputs can be programmed for momentary, or to follow the siren. Programming a "2" in location 132 will activate the auxiliary outputs when these events occur. Programming a "0" in location 132 will cause the Burglary and Panic outputs to activate when the yelping siren is on and the Fire auxiliary output to activate when the steady siren is on.
2. Location 142 has been enhanced to include a bell test at arming by programming a "2". For a bell test at exit delay expiration, program a "4". For a bell test at closing kiss-off, program an "8".
3. The 8980E allows downloading of custom information to 9050 LCD keypads.
4. The 8980E has a "Fire Alarm Verification" feature which can be enabled by programming a "2" in location 143.
5. The AC power loss delay feature is now programmable in 2 minute increments from 0 -14 minutes. It will also delay the same time when reporting an AC power restore. (Do not program a number more than "7".)
6. The 8980E has an 80 event log which stores all events and can be viewed through the download software.
7. Keyswitch arming is allowed through the remote arming input on the PC board. Armed and Ready LED's can be obtained through the auxiliary outputs.
8. Instant zones are delayed during the exit delay time. This can now be changed by programming a "2" in location 197 (see page 27, Location 197: Force Arming, NOTE).
9. The entry delay pre-alarm will no longer override the pulsing keypad sounder which notes a previous alarm.
10. The PCB remote arming pins can be converted to a remote keypad panic zone (see Location 141, page 16).
11. A Supervised 24 Hour Silent zone has been added to the available zone types (see zone type chart, page 11).

### ARM/DISARM CODES 1-7

LOCATION	PAGE	DESCRIPTION	DATA 1	DATA 2	DATA 3	DATA 4	DEFAULT
000-003	9	USER #1 ARM / DISARM CODE					"1-2-3-4"
004-007	10	USER #2 ARM / DISARM CODE					"15" DISABLED
008-011	10	USER #3 ARM / DISARM CODE					"15" DISABLED
012-015	10	USER #4 ARM / DISARM CODE					"15" DISABLED
016-019	10	USER #5 ARM / DISARM CODE					"15" DISABLED
020-023	10	USER #6 ARM / DISARM CODE					"15" DISABLED
024-027	10	USER #7 ARM / DISARM CODE					"15" DISABLED
028-031	10	"GO TO PROGRAM" ACCESS CODE					"9-7-1-3"

### PHONE NUMBERS, ACCOUNT CODES, & FORMATS

032-039	8	PRIMARY PHONE NUMBER DIGITS 1 - 8								"0" DISABLED
040-047	8	PRIMARY PHONE NUMBER DIGITS 9 - 16								"0" DISABLED
048-051	8	PRIMARY ACCOUNT CODE								"0" DISABLED
052	8	PRIMARY FORMAT								"0" DISABLED
053	8	SECONDARY PHONE NUMBER AS BACK-UP								"0" ENABLED
054-061	8	SECONDARY PHONE NUMBER DIGITS 1 - 8								"0" DISABLED
062-069	8	SECONDARY PHONE NUMBER DIGITS 9 - 16								"0" DISABLED
070-073	8	SECONDARY ACCOUNT CODE								"0" DISABLED
074	9	SECONDARY FORMAT								"0" DISABLED

### CONTROL & COMMUNICATOR FEATURES

LOCATION	PAGE	DESCRIPTION	DATA	DEFAULT
075	10	ENTRY DELAY TIME (10 SECOND INCREMENTS)		"3" 30 SECONDS
076	10	EXIT DELAY TIME (10 SECOND INCREMENTS)		"6" 60 SECONDS
077	10	SIREN SHUTDOWN / RECYCLE TIME OUT (2 MINUTE INCREMENTS)		"4" 8 MINUTES
078	10	ZONE 1 TYPE		"3" ENTRY / EXIT
079	10	ZONE 2 TYPE		"5" INT FOLLOWER
080	10	ZONE 3 TYPE		"6" INSTANT
081	10	ZONE 4 TYPE		"6" INSTANT
082	10	ZONE 5 TYPE		"6" INSTANT
083	10	ZONE 6 TYPE		"6" INSTANT
084	10	ZONE 7 TYPE		"6" INSTANT
085	10	ZONE 8 TYPE		"6" INSTANT

LOCATIONS 078-085			
DATA	ZONE TYPES	DATA	ZONE TYPES
1	DAY ZONE	6	INSTANT
2	24 HOUR	7	24 HOUR SILENT
3	ENTRY / EXIT	8	FIRE
4	INTERIOR DELAY	9	SECONDARY DELAY
5	INTERIOR FOLLOWER	10	SUPERVISED 24 HR SILENT

LOCATION	PAGE	DESCRIPTION	ZONE ID	EVENT/EXT CODE	DEFAULT
086-087	11	DURESS COMMUNICATOR CODE			"0" DISABLED
088-089	11	AUX 1 COMMUNICATOR CODE			"0" DISABLED
090-091	11	AUX 2 COMMUNICATOR CODE			"0" DISABLED
092-093	12	KEYPAD PANIC COMMUNICATOR CODE			"2 - 0"
094-095	12	TAMPER COMMUNICATOR CODE			"0" DISABLED
096-097	12	DOWNLOAD COMPLETE COMM CODE			"0" DISABLED
098-099	12	AUTOTEST COMMUNICATOR CODE			"0" DISABLED
100-101	12	FAILURE TO COMMUNICATE REPORT			"0" DISABLED

LOCATION	PAGE	DESCRIPTION	ZONE ID	EVENT/EXT CODE	DEFAULT
102	12	CLOSING COMMUNICATOR CODE		MAN NUMBER	"0" DISABLED
103	12	OPENING COMMUNICATOR CODE		MAN NUMBER	"0" DISABLED
104-105	13	ZONE 1 COMMUNICATOR CODE			"1 - 0"
106-107	13	ZONE 2 COMMUNICATOR CODE			"2 - 0"
108-109	13	ZONE 3 COMMUNICATOR CODE			"3 - 0"
110-111	13	ZONE 4 COMMUNICATOR CODE			"4 - 0"
112-113	13	ZONE 5 COMMUNICATOR CODE			"5 - 0"
114-115	13	ZONE 6 COMMUNICATOR CODE			"6 - 0"
116-117	13	ZONE 7 COMMUNICATOR CODE			"7 - 0"
118-119	13	ZONE 8 COMMUNICATOR CODE			"8 - 0"
120-121	13	AC POWER LOSS COMMUNICATOR CODE			"0" DISABLED
122-123	14	LOW BATTERY COMMUNICATOR CODE			"0" DISABLED
124	14	TROUBLE COMMUNICATOR CODE		ZONE NUMBER	"0" DISABLED
125	14	ZONE BYPASS COMMUNICATOR CODE		ZONE NUMBER	"0" DISABLED
126	14	RESTORE COMMUNICATOR CODE		ZONE NUMBER	"0" DISABLED
127	14	CANCEL COMMUNICATOR CODE		MAN NUMBER	"0" DISABLED

LOCATION	PAGE	DESCRIPTION	DATA	DEFAULT
128	14	ABORT ENABLE		"0" DISABLED
129	14	KEYPAD PANIC SILENT OR AUDIBLE		"0" AUDIBLE
130	14	NUMBER OF ALARMS FOR SWINGER SHUTDOWN		"0" DISABLED
131	15	AUTO BYPASS/ INSTANT ARMING		"0" DISABLED
132	15	SIREN DRIVER OR VOLTAGE OUTPUT / LAST CHANCE TO EXIT BEEP		"0" DRIVER w/BEEP
133	15	LED EXTINGUISH FEATURE		"0" DISABLED
134	15	NUMBER OF DIAL ATTEMPTS		"8" EIGHT ATTEMPTS
135	15	POWER UP CONDITION		"0" LAST CONDITION
136	15	POWER UP DELAY		"0" 60 SEC DELAY
137	15	IMMEDIATE RESTORE BY ZONE		"0" DISABLED
138	15	NO ARMING WITH ZONE BYPASSED		"0" DISABLED
139	16	QUICK ARM DIGIT		"0" DISABLED
140	16	FIRE SIREN CUTOFF INHIBIT		"0" RECYCLES
141	16	SPECIAL KEYPAD COMMAND FUNCTIONS		"4"
142	16	SIREN/BELL TEST FEATURE		"0" DISABLED
143	16	SMOKE POWER RESET AND/OR FIRE ALARM VERIFICATION		"1" POWER RESET
144	16	EUROPEAN PULSE DIAL RATIO		"0" DISABLED
145	17	AUXILIARY OUTPUT #1		"0" BURGLARY
146	17	AUXILIARY OUTPUT #2		"1" FIRE ALARM
147	17	AUXILIARY OUTPUT #3		"2" PANIC/DURESS
148	17	AUXILIARY OUTPUT #4		"3" ARMED STATE
149	17	INVERTING THE AUXILIARY OUTPUTS		"0" HIGH GOING LOW
150	17	DELAY AC POWER LOSS REPORT		"3" 6 MINUTES
151	18	NUMBER OF RINGS TO ANSWER DOWNLOAD CALL		"8" EIGHT RINGS
152	18	NUMBER OF DAYS LEFT UNTIL AUTOTEST		UNDEFINED

LOCATION	PAGE	DESCRIPTION	DATA	DEFAULT													
153	18	PROGRAM CLOCK, CURRENT MONTH		UNDEFINED													
154	18	PROGRAM CLOCK, CURRENT YEAR - TENS DIGIT (1994)		UNDEFINED													
155	18	PROGRAM CLOCK, CURRENT YEAR - ONES DIGIT (1994)		UNDEFINED													
156	18	PROGRAM CLOCK, CURRENT DAY OF MONTH - TENS DIGIT		UNDEFINED													
157	18	PROGRAM CLOCK, CURRENT DAY OF MONTH - ONES DIGIT		UNDEFINED													
158	18	PROGRAM CLOCK, CURRENT HOUR - TENS DIGIT		UNDEFINED													
159	18	PROGRAM CLOCK, CURRENT HOUR - ONES DIGIT		UNDEFINED													
160	19	PROGRAM CLOCK, CURRENT MINUTE - TENS DIGIT		UNDEFINED													
161	19	PROGRAM CLOCK, CURRENT MINUTE - ONES DIGIT		UNDEFINED													
162	19	PROGRAM AUTOTEST TIME, HOUR - TENS DIGIT		"0"													
163	19	PROGRAM AUTOTEST TIME, HOUR - ONES DIGIT		"0"													
164	19	PROGRAM AUTOTEST TIME, MINUTE - TENS DIGIT		"0"													
165	19	PROGRAM AUTOTEST TIME, MINUTE - ONES DIGIT		"0"													
166	19	PROGRAM AUTOTEST TIME REPORTING INTERVALS		"0"													
167	19	ROTATING MAINTENANCE CODES ENABLE		"0" DISABLED													
168	20	ROTATING MAINTENANCE CODES - SEED CODE DIGIT 1		"0"													
169	20	ROTATING MAINTENANCE CODES - SEED CODE DIGIT 2		"0"													
170	20	ROTATING MAINTENANCE CODES - SEED CODE DIGIT 3		"0"													
171	20	ROTATING MAINTENANCE CODES - SEED CODE DIGIT 4		"0"													
172	20	USER #7 (MAINTENANCE CODE) OPENING REPORT		"0" DISABLED													
173	20	USER #7 (MAINTENANCE CODE) CLOSING REPORT		"0" DISABLED													
174	20	PROGRAM ZONES 3 THRU 6 FOR NORMALLY CLOSED OPERATION		"0" SUPERVISED													
175	21	PROGRAM ZONES 1,2,7, & 8 FOR NORMALLY CLOSED OPERATION		"0" SUPERVISED													
176	21	SPLIT REPORT - TAMPER, DOWNLOAD COMPLETE, & AUTOTEST		"0" PHONE #1													
177	22	SPLIT REPORT - AC FAILURE, LOW BAT, OPEN/CLOSE, & MAINT OPEN/CLOSE		"0" PHONE #1													
178	22	SECONDARY ENTRY DELAY TIME		"0"													
179	22	SECONDARY EXIT DELAY TIME		"0"													
180	22	LOOP RESPONSE TIME		"0" 500 MS													
181	23	HOURLY AUTOTEST / AUTO-SET CLOCK		"0"													
182	23	FORMAT OVER-RIDE		"0"													
183	23	FORMAT OVER-RIDE		"0"													
184-185	23	RESERVED		RESERVED													
186	23	ZONE 1 SPECIAL CHARACTERISTICS	<table border="1"> <thead> <tr> <th colspan="2">LOCATIONS 186-193</th> </tr> <tr> <th>VALUE</th> <th>DESCRIPTION</th> </tr> </thead> <tbody> <tr><td>1</td><td>FAST LOOP RESPONSE</td></tr> <tr><td>2</td><td>BYPASS CAPABILITY</td></tr> <tr><td>4</td><td>RESTORE REPORTING</td></tr> <tr><td>8</td><td>CHIME ENABLE</td></tr> </tbody> </table>		LOCATIONS 186-193		VALUE	DESCRIPTION	1	FAST LOOP RESPONSE	2	BYPASS CAPABILITY	4	RESTORE REPORTING	8	CHIME ENABLE	"14"
LOCATIONS 186-193																	
VALUE	DESCRIPTION																
1	FAST LOOP RESPONSE																
2	BYPASS CAPABILITY																
4	RESTORE REPORTING																
8	CHIME ENABLE																
187	23	ZONE 2 SPECIAL CHARACTERISTICS			"14"												
188	23	ZONE 3 SPECIAL CHARACTERISTICS	"14"														
189	23	ZONE 4 SPECIAL CHARACTERISTICS	"14"														
190	23	ZONE 5 SPECIAL CHARACTERISTICS	"14"														
191	23	ZONE 6 SPECIAL CHARACTERISTICS	"14"														
192	23	ZONE 7 SPECIAL CHARACTERISTICS	"14"														
193	23	ZONE 8 SPECIAL CHARACTERISTICS	"14"														
194	23	TELEPHONE LINE FAULT MONITOR		"0" DISABLED													
195	23	TELEPHONE LINE FAULT, DELAY OF ACTIVATION		"3" 30 SECONDS													
196	24	ANSWERING MACHINE DEFEAT ENABLE		"0" DISABLED													
197	24	FORCE ARMING ENABLE		"0" DISABLED													
198	24	TIME FOR AUTOMATIC ARMING, HOUR - TENS DIGIT		"2"													
199	24	TIME FOR AUTOMATIC ARMING, HOUR - ONES DIGIT		"0"													

LOCATION	PAGE	DESCRIPTION	DATA	DEFAULT
200	24	TIME FOR AUTOMATIC ARMING, MINUTE - TENS DIGIT		"0"
201	24	TIME FOR AUTOMATIC ARMING, MINUTE - ONES DIGIT		"0"
202	24	AUTOMATIC ARMING ENABLE		"0"
203	24	DYNAMIC BATTERY TEST		"0"
204	24	DUAL REPORT - TAMPER, DOWNLOAD COMPLETE, & AUTOTEST		"0" PHONE #1
205	25	DUAL REPORT - AC FAILURE, LOW BAT, OPEN/CLOSE, MAINT OPEN/CLOSE		"0" PHONE #1
206	25	DUAL REPORT EVERYTHING		"0"
207	25	CALLBACK PHONE NUMBER CONTROL		"0"
208	26	FORMAT OVER-RIDE		"0"
209	26	FORMAT OVER-RIDE		"0"
210	26	EXIT ERROR COMMUNICATOR CODE		"0"
211	26	RECENT CLOSING COMMUNICATOR CODE		"0"
212-215	26	USER #8 ARM / DISARM CODE		"15" DISABLED
216-219	26	USER #9 ARM / DISARM CODE		"15" DISABLED
220-223	26	USER #10 ARM / DISARM CODE		"15" DISABLED
224-227	26	USER #11 ARM / DISARM CODE		"15" DISABLED
228-231	26	USER #12 ARM / DISARM CODE		"15" DISABLED
232-235	26	USER #13 ARM / DISARM CODE		"15" DISABLED
236-239	26	USER #14 ARM / DISARM CODE		"15" DISABLED
240	26	NUMBER OF DIAL ATTEMPTS TO PHONE #2		"0"
241	26	LISTEN-IN TIME		"0"
242	26	RESERVED		RESERVED
243	26	ENTRY/KEYPAD SOUNDER		"0"
244	27	ZONE #1 SPECIAL CHARACTERISTICS		"8"
245	27	ZONE #2 SPECIAL CHARACTERISTICS		"8"
246	27	ZONE #3 SPECIAL CHARACTERISTICS		"8"
247	27	ZONE #4 SPECIAL CHARACTERISTICS		"8"
248	27	ZONE #5 SPECIAL CHARACTERISTICS		"8"
249	27	ZONE #6 SPECIAL CHARACTERISTICS		"8"
250	27	ZONE #7 SPECIAL CHARACTERISTICS		"8"
251	27	ZONE #8 SPECIAL CHARACTERISTICS		"8"
252	27	AUXILIARY 3 COMMUNICATOR CODE		"0"
253	27	AUXILIARY 3 EXTENDED COMMUNICATOR CODE		"0"
254	27	USER ON SITE COMMUNICATOR CODE		"0"
255	27	CROSS ZONING TIME (MINUTES)		"5"

LOCATIONS 244 - 251	
VALUE	DESCRIPTION
1	CROSS ZONE
2	ENTRY GUARD ZONE
4	GROUP BYPASS ZONE
8	TROUBLE REPORTING

**REMEMBER! AFTER ALL DATA HAS BEEN ENTERED, PRESS [9]-[2]-[0]-[#] TO STORE DATA IN EEPROM!**

### DOWNLOADING ACCESSIBLE LOCATIONS

LOCATION	PAGE	DESCRIPTION	DATA	DEFAULT
256-263	28	CONTROL PANEL ACCESS CODE		"8 6 0 0 0 0 0 0"
264-271	28	CALLBACK PHONE NUMBER - DIGITS 1 - 8		"0" DISABLED
272-279	28	CALLBACK PHONE NUMBER - DIGITS 9 - 16		"0" DISABLED
280	28	ANSWERING MACHINE DEFEAT		"0" DISABLED
281	28	LOCAL PROGRAMMING LOCKOUT		"0" NOT LOCKED
282	28	CONTROL PANEL SHUTDOWN		"0" CONTROL ON



## APPENDIX 1 - REPORTING IN SIA FORMAT

The 8980E has the ability to report SIA level 1 transmissions to either or both phone numbers. Each report in SIA consists of an Event Code and a Zone or User ID. The Zone or User ID is programmed in the first digit of each report. When programming the event code (the second digit) for zones 1-8 (locations 105, 107, 109, 111, 113, 115, 117, or 119), programming a zero will cause the event code to follow the zone type for that zone. The event code for the zone type can be overridden by programming a digit from the table below. Duress (location 87), AUX 1 (location 89), AUX 2 (location 91), and keypad Panic (location 93) must be programmed from the table below.

Programmed Event Code	SIA Code	Description
1	FA	Fire Alarm
2	PA	Panic alarm
3	BA	Burglary Alarm
4	GA	Gas Alarm
5	KA	Heat Alarm
6	WA	Water Alarm
7	QA	Emergency Alarm
8	SA	Sprinkler Alarm
9	UA	Untyped Alarm
10	HA	Holdup Alarm
11	MA	Medical Alarm
12	ZA	Freeze Alarm
13	TA	Tamper Alarm
14	RP	Periodic Test
15	YF	System Fault (If Zone ID = 0)
15	ET	Expander Module Trouble (If Zone ID = 1)
15	ET	RF Loss of Supervision (If Zone ID = 2)
15	TA	Sensor Tamper (If Zone ID = 3)
15	XT	Sensor Low Battery (If Zone ID = 4)

The following reports will send fixed event codes regardless of the number programmed in the event code location:

Event	SIA Code	Event Code Location
Keypad Tamper	TA	95
Download Complete	RS	97
Autotest	RP	99
Fail to Communicate	RT	101
Closing	CL	102
Opening	OP	103
AC Loss	AT	121
Low Battery	YT	123
Trouble	*T	124
Bypass	*B	125
Bypass Restore	*U	125+126
Restore	*R	126
Cancel	OC	127
Maintenance Open	OP	172
Maintenance Close	CL	173
Exit Error	EE	210
Recent Closing	CR	211
Auxiliary 3	UA	253
User on site	YY	254

**\*These will send the event code for the zone bypassed, restored, or in trouble.**

## APPENDIX 2 - REPORTING IN CONTACT ID

The 8980E has the ability to report Ademco Contact ID transmissions to either or both phone numbers. Each report in Contact ID consists of an Event Code and a Zone or User ID. The zone or User ID is programmed in the first digit of each report. When programming the event code (the second digit) for zones 1-8 (locations 105, 107, 109, 111, 113, 115, 117, or 119), programming a zero will cause the event code to follow the zone type for that zone. The event code for the zone type can be overridden by programming a digit from the table below. Duress (location 87), AUX 1 (location 89), AUX 2 (location 91), and keypad Panic (location 93) must be programmed from the table below.

Programmed Event Code	Contact ID Code	Description
0	122	Silent Panic (for Loc. 93 only)
1	110	Fire Alarm
2	120	Panic alarm
3	130	Burglary Alarm
4	131	Perimeter Alarm
5	132	Interior Alarm
6	133	24 Hour Burglary
7	134	Entry Alarm
8	135	Day/Night Alarm
9	150	Non-Burglary 24 Hour
10	121	Duress Alarm
11	100	Medical Alarm
12	123	Audible Panic Alarm
13	137	Tamper Alarm
14	602	Periodic Test
15	300	System Fault (If Zone ID = 0)
15	333	Expander Module Trouble (If Zone ID = 1)
15	381	RF Loss of Supervision (If Zone ID = 2)
15	383	Sensor Tamper (If Zone ID = 3)
15	384	Sensor Low Battery (If Zone ID = 4)

The following reports will send fixed event codes regardless of the number programmed in the event code location:

Event	Contact ID Code	Event Code Location
Keypad Tamper	137	95
Download Complete	412	97
Autotest	602	99
Failed to Communicate	354	101
Closing	401	102
Opening	401	103
AC Loss	301	121
Low Battery	302	123
Trouble	380	124
Bypass	570	125
Restore	*	126
Cancel	406	127
Maintenance Open	401	172
Maintenance Close	401	173
Exit Error	138	210
Recent Closing	401	211
Auxiliary 3	140	253
User on site	605	254

**\* This will send the event code for the zone restored.**

## **INSTRUCTIONS FOR UNDERWRITERS LABORATORIES 985 AND 1023 INSTALLATIONS**

**When installing a Ranger 8980E in compliance with UL-985 (Residential Fire) and UL-1023 (Residential Burglary) the following instructions must be followed.**

- The Ranger 8980E Control Panel and keypad must be mounted indoors and within the protected area.
- The rechargeable system battery should be replaced at no more than four year intervals. The Ranger 8980E should be tested annually with and without A.C. power. This will insure that the battery is connected and adequately charged at the time of the test.
- All electrical wiring connected to the Ranger 8980E must be installed in accordance with the National Electrical Code, ANSI and NFPA standards.
- When the built-in digital communicator is utilized in conjunction with a U.L. installation it must report at a minimum a burglary zone, a fire zone, and A.C. power failure. The minimum number of dialing attempts programmed must be 5 if one phone number is used and 3 if two phone numbers are used. The maximum number of dialing attempts programmed must be 10 if one phone number is used and 5 if two phone numbers are used.
- Swinger shutdown feature must not be enabled.
- Control panel shutdown must not be enabled.
- U.L. has tested the Ranger 8980E to be compatible with the Silent Knight No. 9000 receiver.
- All interconnections to the Ranger 8980E must be made using U.L. labeled limited energy cable.
- Use Caddx Part #EOL-34UL for all U.L.985 installations.
- Force Arming and/or Automatic Arming shall not be enabled.
- (1) For 24 hours of standby power using a 6.5 AH battery, limit auxiliary power load to 130 mA.  
(2) For 24 hours of standby power using a 17.2 AH battery, limit auxiliary power load to 400 mA.

### **TYPICAL FIRE INSTALLATION LAYOUT**

NOTE: Installation of fire detection equipment in all rooms and areas of the household is suggested for early warning fire detection. A smoke detector should be installed on each level and in each separate sleeping area (the vicinity of, but outside of the bedroom), with heat or smoke detectors in living rooms, dining rooms, bedrooms, kitchens, hallways, attics, furnace rooms, closets, utility and storage rooms, basements, and attached garages.

## **LOCAL TELEPHONE COMPANY INTERFACE INFORMATION**

### **TELEPHONE CONNECTION REQUIREMENTS**

Except for telephone company provided ringers, all connections to the telephone network shall be made through standard plugs and standard telephone company provided jacks or equivalent in such a manner as to allow for immediate disconnection of the terminal equipment. Standard jacks shall be so arranged that if the plug connected thereto is withdrawn, no interference to the operation of the equipment at the customers premises which remains connected to the telephone network, shall occur by reason of such withdrawal.

### **INCIDENCE OF HARM**

Should terminal equipment or protective circuitry cause harm to the telephone network, the telephone company shall, where practical, notify the customer that temporary discontinuance of service may be required; however, where prior notice is not practical, the telephone company may temporarily discontinue service if such action is deemed reasonable in the circumstances. In the case of such temporary discontinuance, the telephone company shall promptly notify the customer who will be given the opportunity to correct the situation. The customer also has the right to bring a complaint to the FCC if he feels the disconnection is not warranted.

### **CHANGES IN TELEPHONE COMPANY EQUIPMENT OR FACILITIES**

The telephone company may make changes in its communications facilities, equipment, operations, or procedures where such action is reasonably required and proper in its business. Should any such change render the customers terminal equipment incompatible with the telephone company facilities, the customer shall be given adequate notice to make modifications to maintain uninterrupted service.

### **GENERAL**

The FCC prohibits customer provided terminal equipment be connected to party lines.

### **IMPORTANCE OF THE RINGER EQUIVALENCE NUMBER**

The Ringer Equivalence Number of this device is 0.0 B. This number is a representation of the electrical load that it applies to your telephone line.

### **MALFUNCTION OF THE EQUIPMENT**

In the event that the device should fail to operate properly, the customer shall disconnect the equipment from the telephone line to determine if it is the customers equipment that is not functioning properly. If the problem is with the device, the customer shall discontinue use until it is repaired.

### **EQUIPMENT INFORMATION**

MANUFACTURER OF CONNECTING EQUIPMENT: CADDX CONTROLS INC., FCC REGISTRATION NUMBER: GCQ4DC-17266-AL-E, RINGER EQUIVALENCE: 0.0 B

## SPECIFICATIONS

OPERATING POWER	16.5 VAC 25 VA Transformer
AUXILIARY POWER	12 VDC 500mA (400mA for U.L.)
LOOP RESISTANCE	300 Ohms Maximum
BUILT-IN SIREN DRIVER	2-tone (Steady and Yelp)
LOOP RESPONSE	Selectable to 500mS
OPERATING TEMPERATURE	32 to 120 degrees F
KEYPAD DIMENSIONS	5.50" Wide 4.25" High .850" Deep
METAL ENCLOSURE	11.25" Wide 11.25" High 3.50" Deep
SHIPPING WEIGHT	9 lbs.

### FIVE YEAR LIMITED WARRANTY

CADDX CONTROLS, INC. GUARANTEES THIS PRODUCT AGAINST DEFECTIVE PARTS AND WORKMANSHIP FOR TWENTY-FOUR (24) MONTHS FROM DATE OF MANUFACTURING. IF ANY DEFECT APPEARS DURING THE WARRANTY PERIOD RETURN IT TO CADDX, POSTAGE PREPAID. THE UNIT WILL BE REPAIRED AND RETURNED.

FOR THE REMAINING 36 MONTHS OF WARRANTY, THE UNIT WILL BE REPAIRED FOR A FEE NOT TO EXCEED \$10.00 PLUS SHIPPING AND HANDLING.

CADDX ASSUMES NO LIABILITY FOR CONSEQUENTIAL OR INDIRECT DAMAGE AND ACCEPTS NO RESPONSIBILITY FOR REPAIRING DAMAGE TO THE PRODUCT CAUSED BY MISUSE, CARELESS HANDLING, OR WHERE REPAIRS HAVE BEEN MADE BY OTHERS.

NO OTHER GUARANTEE, WRITTEN OR VERBAL, IS AUTHORIZED BY OR ON BEHALF OF CADDX CONTROLS, INC., GLADEWATER, TEXAS

CADDX CONTROLS, INC  
1420 NORTH MAIN STREET  
GLADEWATER, TEXAS 75647  
TOLL FREE 800-727-2339  
FAX 903-845-6811